

**Uniden®**

**UIP 160P**

**SERIES**

**OWNER'S**

**MANUAL**

**OWNER'S MANUAL**

# Contents

Welcome/Features/Terminology	2	Phonebook (Storing Phone Numbers, Names, Distinctive Rings and Speed Dial)	38
Controls & Functions	5	Chain Dialing	39
Setting up the Phone	7	Steps for Entering Names and Special Characters	40
Safety Recommendations	7	Viewing the Phonebook	42
Before You Start!	8	Making Calls Using the Phonebook	43
Install the rechargeable battery pack into the handset	12	Speed Dialing	43
Expanding Your Phone	13	Editing or Erasing a Phonebook Entry	44
Ten Handset Expandability	13	Copying Phonebook Entries	45
Backwards/Forwards Compatibility	13	Caller ID and CIDCW (Caller ID on Call Waiting)	46
Connecting the Expansion Handset Charger	13	Viewing the Caller ID List	47
Register the Handset	14	Deleting a Caller ID Record	48
Installing the Beltclip	16	Deleting All Caller ID names/numbers	49
Headset Installation	16	Using the Caller ID Message List	49
Display and Icons	17	Multi-Handset Features	51
Soft Key Function	18	Using the DirectLink Two-Way Radio Feature	51
Main Menu Options	19	Using the Room/Baby Monitor	53
Setting Menu Options	20	Using the Intercom	54
Using the interface	20	Transferring a Call	55
Handset Setup	20	Troubleshooting	56
Global Setup	28	Getting Help	56
Using Your Phone	30	Installation Troubleshooting	57
Calling with Packet8 service	30	Resetting the UIP160P	58
Using the Speakerphone	30	Logging into the UIP160P	59
Making and Receiving Calls	31	Common Issues	60
Call Waiting	32	Note on Power Sources	64
Placing a Call on Hold	32	Battery replacement and handling	64
Redialing a Call	33	Power Failure	64
Adjusting the Earpiece and Speaker Volume	34	Battery Life	65
Temporarily Muting the Ringer	34	Cleaning the battery charging contacts	65
Mute Microphone	35	General Information	66
Privacy Mode	35	Liquid Damage	67
Traveling Out of Range	35	Precautions & Warranty	68
Conferencing	36	I.C. Notice	69
Find Handset	36	Index	70
Using One Touch Voice Mail Access	37	Main Menu Flow Chart	71
Resetting the New Message LED	37		

## Welcome

With the UIP160P voice-over-Internet Protocol (VoIP) telephone, Packet8 VoIP service and your broadband connection, you can access the Internet and make phone calls simultaneously. The UIP160P can connect directly to your broadband modem or can connect to a router or switch in your home network. It generates and receives voice data and forwards data traffic to your computer or network.

**Note: Some illustrations in this manual may differ from the actual unit for explanation purposes.**

## Features

- 5.8GHz Digital Expandable
- 10 Multi-Handset Expandability
- Hands-Free Duplex Speakerphone in the Handset
- Caller ID (subscribe through local telephone company)
- 100 programmable Memory Locations
- Trilingual Display Options (English, French and Spanish)
- Intercom/Call Transfer Between Handsets
- 20 Distinctive Ring Options (10 ringer tones and 10 melody ringers)
- Mute and Hold Features
- DirectLink™ Mode
- Room/Baby Monitoring
- Battery Level Indicator
- Clock Display
- Animation Displays

This series features **AutoTalk™** and **AutoStandby™**. AutoTalk allows you to answer a call by just removing the handset from the cradle so you don't have to waste time pushing buttons. AutoStandby allows you to hang up by simply returning the handset to the cradle.

To protect you against mis-billed calls that might result from your phone being activated by other equipment, this series has **Random Code™** digital security, which automatically selects one of more than 10,000,000 digital security codes for the handset and base.

Digital Spread Spectrum Technology uses a wider frequency band than standard digital transmissions. The result is a more secure conversation with the clarity of digital sound, extended range, and minimal interference from other cordless phones.

**IntegriSound™** Built in sound quality which provides life-like conversations.

With **DirectLink™** mode, you can use 2 or more handsets as radio transceivers (walkie-talkies).

Be sure to visit our web site: [www.uniden.com](http://www.uniden.com)

Uniden® is a registered trademark of Uniden America Corporation.



AutoTalk, AutoStandby, DirectLink, IntegriSound, and Random Code are trademarks of Uniden America.

### **Accessibility**

If you have a disability and need customer service assistance or if you have any questions about how Uniden's products can accommodate persons with disabilities, please call the accessibility voice/TTY line: 1-800-874-9314

A representative is available to talk to you M-F, 8:00 am to 5:00 pm, CST. After hours, you can leave us a message, and we will call you back. Information is also available on our website, [www.uniden.com](http://www.uniden.com), under the "Accessibility" link.

# Terminology

- **Standby Mode** - The handset maybe sitting or off the cradle, but is NOT in use. *talk/flash* or  has not been pressed.
- **Talk Mode** - The handset is off the cradle and *talk/flash* or  has been pressed, and enabling a dial tone.
- **VoIP** - Voice over Internet Protocol, a method of sending voice signals over broadband Internet connections.
- **Station** - The main base or any registered handset.
- **Configuration utility** - The internal user interface that allows you to change configurations settings in the UIP160P. You can access the configuration utility with an Internet web browser.

# Controls & Functions

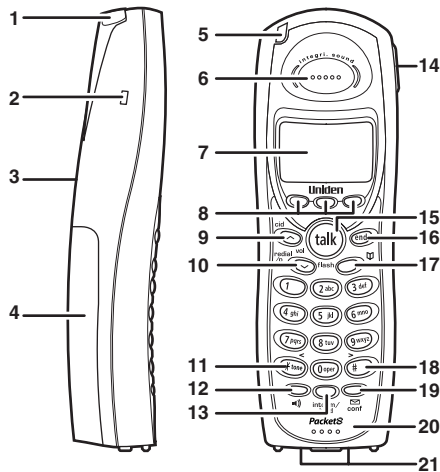

1. Handset Antenna
2. Beltclip Hole
3. Speakerphone Speaker and Ringer
4. Handset Battery Compartment
5. New Message LED
6. Handset Earpiece
7. LCD Display
8. **soft** Keys (P. 18)
9. **cid/vol/∧** (volume up) (P. 47, 34 & 20)
10. **redial/p/vol/∨** (volume down) (P. 33, 31, 34 & 20)
11. **\*/tone/<** (P. 40)
- 12.
13. **Ⓜ** (speaker) (P. 30)
14. **intcom** (intercom)/**hold** (P. 54 & 32)
15. Headset Jack Cover
16. **talk/flash** (P. 31 & 32)
17. **end** (P. 31)
18. **☎** (phonebook) (P. 38)
19. **#/>** (P. 41)
20. **☒** (message)/**conf** (conferencing) (P. 37)
21. Handset Microphone
22. Handset Charging Contacts

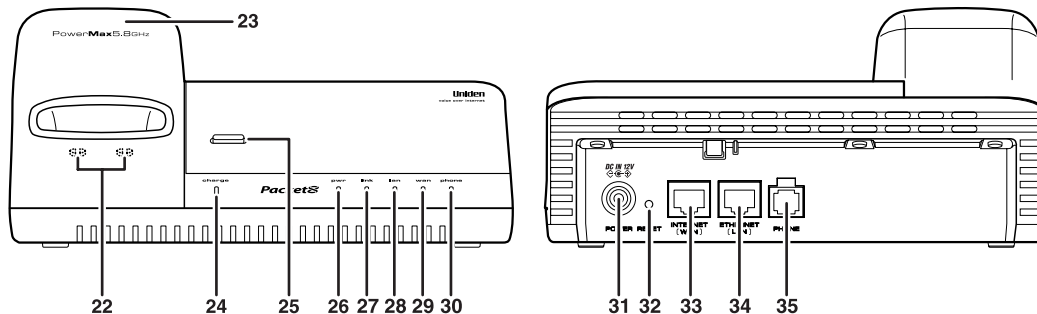

- 23. Base Charging Contacts
- 24. Base Antenna
- 25. Charge LED
- 26. *find hs* (handset) (P. 36)
- 27. pwr (power) LED
- 28. link LED
- 29. lan LED
- 30. wan LED
- 31. phone LED
- 32. POWER port

- 33. RESET switch
- 34. INTERNET (WAN) port
- 35. ETHERNET (LAN) port
- 36. PHONE port

# Setting up the Phone

## **Safety Recommendations**

To ensure general safety, follow these guidelines:

- Do not open or disassemble this product.
- Do not expose the product to moisture.
- Do not perform any action that creates a potential hazard to people or makes the equipment unsafe.
- Ultimate disposal of this product should be handled according to all national laws and regulations.
- Do not touch the wires on the cable ports or the wires of cables connected to a port as hazardous voltage may be present on these wires when the equipment is powered on.
- The plug-socket combination must be accessible at all times because it serves as the power disconnect.
- To avoid electric shock, do not connect the UIP160P to any RJ-11 telephone wall jacks. This could damage the UIP160P or the telephone wiring in the building.
- Do not work on the system or connect or disconnect cables if lightning or thunder are present in your area.
- Do not cover or block the air vents on the UIP160P. Overheating can cause permanent damage to the unit.
- Read the instructions completely before connecting the system to its power source.

## 911 Service Notice

Packet8 offers Enhanced 911 calling as a standard feature of its Internet phone service. However, there are certain circumstances, when you dial 911 from a phone connected to the Packet8 service, where E911 service may not function, or the E911 service may be in some way limited by comparison to traditional 911 service. Please review the Terms and Conditions at [www.packet8.net](http://www.packet8.net) for additional information.

## Before You Start!

Visit the Packet8 activation website <http://activate.packet8.net/> and enter the MAC address ID found on the bottom of your UIP160P. After you activate the UIP160P, you will receive an email containing a 10-digit activation code. You will need this activation code in Step 3.

## STEP 1: Check Your Equipment

Check your broadband setup and the other equipment you will need:

- A broadband modem and a broadband Internet connection
- A computer with an Ethernet port (or a local Ethernet switch or router)
- One CAT-5 Ethernet cable
- The Packet8 10-digit activation code that was emailed to you when you created your account. (If you don't have this email, go to [www.packet8.net](http://www.packet8.net) and enter the email address and password used to create the account in the account sign in at the top of the screen.)
- If you want to use an analog phone or fax machine with the UIP160P, you will need a standard telephone cable (RJ-11).



If you ordered your UIP160P directly from Packet8, it will already be activated for you. Your 10-digit activation code was in the confirmation email you received when your UIP160P shipped. (If you don't have this email, go to [www.packet8.net](http://www.packet8.net) and enter the email address and password used to create the account in the account sign in page.)

## Check Your Broadband Configuration

The UIP160P supports the two most common broadband connection protocols: DHCP and PPPoE. If your broadband connection uses DHCP, you do not need to change any settings on the UIP160P. If your broadband connection uses PPPoE, you will need to enter your user name and password in step 3. If your broadband provider has given you a static IP address, you will need to enter that information in the UIP160P.

See the User Interface Guide at [www.uniden.com/voip](http://www.uniden.com/voip) for more information on configuring your UIP160P.

## STEP 2: Connect Your UIP160P

Once your account is set up, you can connect your UIP160P.

- 1) Use the included Ethernet cable to connect your broadband modem to the RJ-45 port labeled **WAN**. If you use a switch or a router for your local network, then you can connect it to the WAN port instead.

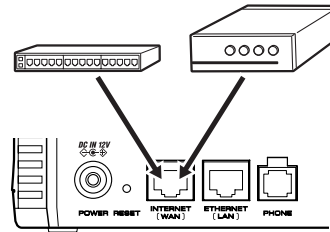

- 2) Use another Ethernet cable to connect your PC to the RJ-45 port labeled **LAN**.

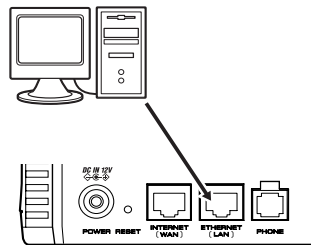

- 3) OPTIONAL: If you have a second phone you want to use connect it to RJ-11 port labeled **PHONE**.



### CAUTION

*Do not connect the UIP160P to a regular telephone wall jack.*

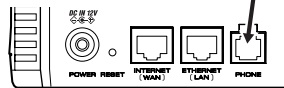

- 4) Use the included AC adapter to connect the **POWER** port to a 100-240 Vac continuous power outlet.

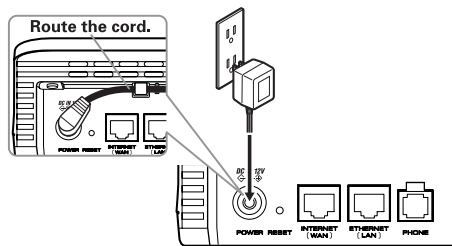

### CAUTION

*To avoid risk of fire or electrical hazard, use ONLY the included AC adapter!*



PHONE is not a separate line. Any phone connected to PHONE will share your VoIP line with all the UIP160P's cordless handsets.

All the LEDs will flash several times, and the PWR LED will remain on. If the UIP160P was properly recognized by Packet8's network, the link LED will remain on. Test your connection by making a call with the handset and browsing to a web page from your PC. If you have any difficulty, see the Troubleshooting section. See the User Interface Guide at [www.uniden.com/voip](http://www.uniden.com/voip) for more information on configuring your UIP160P.

### **Step 3 Activate your Packet8 Service**

Once you have connected your UIP160P, you can activate your Packet8 service

- You will need your 10-digit activation code that was sent to you by email when your Packet8 order shipped. (You can also obtain your activation code at [www.packet8.net](http://www.packet8.net) by signing in at your account page.)
- Pick up your telephone handset and dial the Activation Service number \*\*012-0001.
- Follow the voice instructions and enter your 10-digit activation code.
- When you enter a valid code, your account will be activated and your Packet8 phone number will be emailed to you. This Packet8 phone number can also be found in your account details page after signing in at [www.packet8.net](http://www.packet8.net).

## Install the rechargeable battery pack into the handset

- 1) Press down on the handset battery case cover (use the finger indentation for a better grip) and slide the cover downward to remove.
- 2) Plug the battery pack connector (red & black wires) into the jack inside the battery compartment. (The connector notches fit into the grooves of the jack only one way.) Match the wire colors to the polarity label in the battery compartment, connect the battery and listen for a click to insure connection.
- 3) Make sure you have a good connection by slightly pulling on the battery wires. If the connection is secure, the battery jack will remain in place.
- 4) Place the battery case cover back on the handset and slide it upwards until it clicks into place.
- 5) Place the handset in the base with the keypad facing forward.
- 6) Make sure that the charge LED illuminates. If the LED does not illuminate, check to see that the AC adapter is plugged in and the handset makes good contact with the base charging contacts.
- 7) Charge the handset battery pack for at least 15-20 hours before using your new cordless handset for the first time.

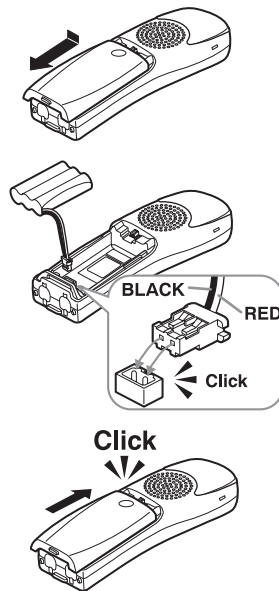

- Use only the Uniden (BT-446) rechargeable battery pack supplied with your cordless telephone.
- Replacement battery packs are also available through the Uniden Parts Department (see back cover page).

# Expanding Your Phone

## Ten Handset Expandability

Your phone supports up to ten handsets, including any handsets supplied with your phone. Expansion handsets can be placed anywhere AC power is available to connect the handset charger. Up to 2 handsets can be used in DirectLink Mode or on an intercom call without interfering with incoming calls. You can also have a 3-way conference among 2 handsets and an outside line. All handsets ring when a call is received.

10 Handsets

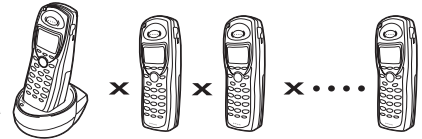

## Backwards/Forwards Compatibility

Your phone is compatible with other Uniden 5.8GHz Digital Expandable Handsets. Compatible models include the TCX805, TCX400, TCX440, and ELX500. (Please check [www.uniden.com](http://www.uniden.com) for an updated list of expansion handsets compatible with this series.)

## Connecting the Expansion Handset Charger

- 1) Connect the AC adapter to the **DC IN 9V** jack and to a standard 120V AC wall outlet.
- 2) Set the charger on a desk or tabletop, and place the handset in the charger with the keypad facing forward. (See "Install the rechargeable battery pack into the handset" on page 12.)

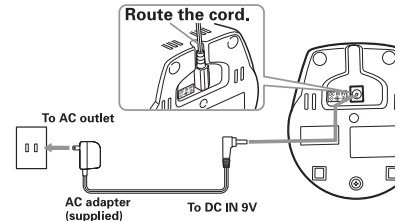

Charge the handset battery pack for at least 15-20 hours before using your new cordless telephone for the first time.



- An extra handset can be registered when the main base is in standby mode.
- If a handset has ever been registered to a different base, you must de-register the handset before you can register it to the new base (see page 15).

## Register the Handset

Expansion handsets must be registered to the base before you can use them. Only one handset can be registered at a time.

Handsets supplied with the phone are registered to the base by the factory. When you register an extra handset to the base, the handset ID will be assigned.

Before an expansion handset is registered, the battery pack **MUST** be charged for 15 hours.

### Register the expansion handset to main base

#### To register TCX805, simply place it in the main base.

While the handset is registering, `Handset Registering` will appear in the LCD. When `Registration complete.` is displayed, the handset has been registered to the base. If `Registration failed.` appears, please try these steps again.

#### To register a ELX500, TCX440, or TCX400 handset, follow the steps below:

- 1) Disconnect the AC adapter from the main base.
- 2) While pressing down **find handset**, reconnect the AC adapter.
- 3) On the handset, press and hold # until you hear a beep.

While the handset is registering, `Handset Registering` will appear in the LCD. When `Registration complete.` is displayed, the handset has been registered to the base. If `Registration failed.` appears, please try these steps again.

## De-register the Handset

You can deregister the handset's ID from the main base unit or the base ID from the handset. You will usually only deregister the handset if you want to change the base you use it with, if you are having a problem with your phone, or if you need to change the digital security code. The digital security code is an identification code used to connect the handset and the base unit. Normally, setting the code is not necessary. In the rare situation that you suspect another cordless telephone is using the same security code, you can change the code by de-registering and reregistering all handsets.

- 1) In standby mode, press the **MENU** soft key and select Deregister HS. Then, press the **OK** soft key. Deregister HS? appears.
- 2) Press *cid/vol/∧* or *redial/p/vol/∨* to select Yes and then the **OK** soft key. When de-registration is complete you will hear a confirmation tone, and Deregistration Complete appears.
- 3) After de-registering the handset, place the handset to the base to register. You must re-register the handset before you can use it.



# Installing the Beltclip

## To attach the beltclip

Insert the beltclip into the holes on each side of the handset.  
Press down until it clicks.

## To remove the beltclip

Pull either side of the beltclip to release the tabs from the holes.



# Headset Installation

Your cordless handset may be used with an optional headset. To use this feature, insert the headset plug into the headset jack. Your phone is ready for hands-free conversations. (Headsets may be purchased by calling the Uniden Parts Department or visiting the web site. See back cover page.)

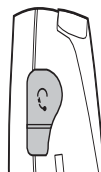

# Display and Icons

Example of the standby mode display



- Ringer off icon (when the ringer is off)/ day of the week and time / battery icon
- Handset ID and Banner
- Number of new Caller ID calls received (If there are no new Caller ID messages, the Handset ID appears here.)

ICON	Appears During	DESCRIPTION
	Standby/Talk	<b>Battery</b> icons indicate the handset battery status. This icon changes depending on the battery status (empty, low, medium and full).
	Standby	The <b>Ringer off</b> icon indicates that ringer is turned off.
	Talk	The <b>Mute</b> icon appears when you mute the handset.
	Talk	The <b>Speaker</b> icon appears when the handset speaker phone is used.
	Talk	The <b>Privacy</b> icon appears when the Privacy Mode is turned on.

# Soft Key Function

"Soft" keys are keys that change function during the operation of the phone. There are three soft keys on each handset. Soft Keys allow you to:

- Access the main menu
- Redial one of the last three numbers dialed from the handset

The function of each soft key is determined by the icon that appears directly above it. For example, when the handset is in standby mode, pressing soft key 2 will access the main menu. When the handset is in talk mode, pressing soft key 1 will mute the microphone.

Complete information on the features controlled by the soft keys can be found under each feature.

## In standby mode

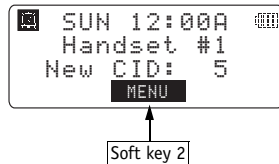

## In talk mode

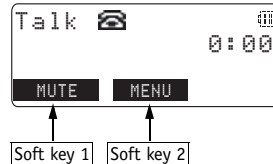



- For Global Setup and Deregister HS menu options, make sure the line is not in use and the handsets are within range of the base.
- Main menu flow chart is provided on page 71.

## Main Menu Options

Your phone has five main menu options: **DirectLink Mode, Room Monitor, Handset Setup, Global Setup** and **Deregister HS**.

### Default Settings

The default settings set from the factory match the features that most people use. You may not need to change them. The table below lists the default settings.

Function	Default Settings	Function	Default Settings
Edit Voice Mail	None	Day & Time	SUN 12:00 AM
Ringer Volume	High	CW / CWDX	CW on/CWDX off
Ringer Tone	Flicker	Area Code	None
Distinctive Ring	On	Dial Mode	Tone
Auto Talk	Off	Voice Mail Tone	On
Anykey Answer	Off		
Banner	" "		
Language	English		
LCD Contrast	level 5		
Key touch tone	On		
Animation Screen	On		
Room Monitor (allow monitoring)	On		

# Setting Menu Options

## Using the interface

Below are some tips for using the software interface on your phone.

- Press the **MENU** soft key to access the main menu.
- Use **cid/vol/^** and **redial/p/vol/v** to scroll through options.
- Press the **OK** soft key to make a selection.
- Press the **BACK** soft key to return to the previous screen.
- Press **end** to exit the menu.



## Handset Setup

The following submenu options must be set separately for each handset.

### Selecting a Ringer Volume

You can choose from one of three ringer volumes.

- 1) Press the **MENU** soft key. Select the Handset Setup menu, and then the Ringer Volume submenu.
- 2) Press **cid/vol/^** or **redial/p/vol/v** to select HIGH, LOW, or OFF.
- 3) Press the **OK** soft key. You will hear a confirmation tone.

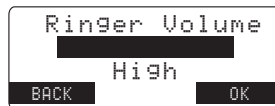

## Selecting a Ringer Tone

Ringer Tone lets you choose from 10 ringer tones or 10 melodies:

- Ringers (Flicker, Clatter, Soft Alert, Wake Up, Light Bug, Beep Boop, Tone Board, Chip Chop, Party Clap, Reminder)
- Melodies (Beethoven's Symphony #9 [Beethoven9], For Elise [Elise], We Wish You A Merry Christmas [Merry- Xmas], Home Sweet Home [Hm Swt Hm], Lorri Song #6 [Lorri Song], When Irish Eyes Are Smiling [Irish Eyes], Aura Lee, Let Me Call You Sweet Heart [Sweetheart], Star Spangled Banner [Star Spngl], Old MacDonald [Old MacDld])

You must set the ringer tone separately on each handset.

- 1) Press the **MENU** soft key. Select the Handset Setup menu, and then the Ringer Tones submenu.
- 2) Press **cid/vol/^** or **redial/p/vol/v** to move the pointer. You will hear the ringer or melody as you scroll through the options.
- 3) When you reach the ringer tone you want, press the **OK** soft key. You will hear a confirmation tone.

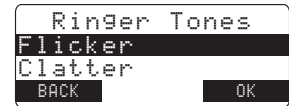

## Distinctive Ring Setup

Distinctive Ring allows you to assign a designated ring tone to a stored phonebook number. When a call is received and the Caller ID information matches the information in one of the phonebook entries, the phone uses the distinctive ring assigned to that particular Caller. You can assign distinctive rings to multiple phonebook entries. Switching the setting to Distinctive Off disables distinctive ringing: all incoming calls will have a normal ring tone. Switching to Distinctive On activates all programmed distinctive rings.

- 1) Press the **MENU** soft key. Select the Handset Setup menu, and then the Distinctive Ring submenu.
- 2) Press **cid/vol/^** or **redial/p/vol/v** to select On or Off.
- 3) Press the **OK** soft key. You will hear a confirmation tone.



## Setting AutoTalk

AutoTalk allows you to answer the phone simply by removing the handset from the cradle. You do not have to press any buttons to answer the call.

- 1) Press the **MENU** soft key. Select the Handset Setup menu and then the AutoTalk submenu.
- 2) Press **cid/vol/^** or **redial/p/vol/v** to select On or Off.
- 3) Press the **OK** soft key. You will hear a confirmation tone.



### Setting Anykey Answer

Any Key Answer allows you to answer the phone by pressing any number key, *\*/tone/<*, or *#/>* on the handset.

- 1) Press the **MENU** soft key. Select the Handset Setup menu, and then the Anykey Answer submenu.
- 2) Press *cid/vol/^* or *redial/p/vol/v* to select On or Off.
- 3) Press the **OK** soft key. You will hear a confirmation tone.



### Setting the True Banner

True Banner lets you customize the name your handset displays. The name will be displayed on the LCD screen during Standby Mode, Intercom, Intercom Hold, Room Monitor, DirectLink, and Copy Phonebook operation. The banner name will be displayed on the receiving handset as well.

- 1) Press the **MENU** soft key. Select the Handset Setup menu, and then the Banner submenu.
- 2) Use the number keypad (*0-9*), *\*/tone/<*, *#/>*, or the **DELETE** soft key to enter or edit the name.
- 3) Press the **OK** soft key. You will hear a confirmation tone.

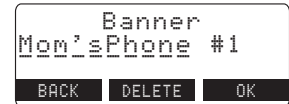

## Selecting a Language

You can change which language the menu display will use. Choose from English, French, or Spanish.

- 1) Press the **MENU** soft key. Select the Handset Setup menu, and then the Language submenu.
- 2) Press **cid/vol/^** or **redial/p/vol/v** to choose English, Français (French), or Español (Spanish).
- 3) Press the **OK** soft key. You will hear a confirmation tone.



## Adjusting the LCD Contrast

Contrast adjusts the handset LCD brightness. Choose one of the 10 levels for optimum viewing.

- 1) Press the **MENU** soft key. Select the Handset Setup menu and then the LCD Contrast submenu.
- 2) Press **cid/vol/^** or **redial/p/vol/v** to adjust the contrast of the LCD (10 levels.)
- 3) Press the **OK** soft key. You will hear a confirmation tone.



## Setting the Key Touch Tone

Key Touch Tone is the tone your keypad makes when keys are pressed. You can turn this tone on or off.

- 1) Press the **MENU** soft key. Select the Handset Setup menu and then the Key Touch Tone submenu.
- 2) Press *cid/vol/∧* or *redial/p/vol/∨* to select On or Off.
- 3) Press the **OK** soft key. You will hear a confirmation tone.



### Setting the Animation Screen

The Animation screen displays animation on the handset LCD. The animations will be displayed on the LCD screen during a call, ringer volume setting, when you hang up, and so on.

- 1) Press the **MENU** soft key. Select the Handset Setup menu and then the Animation Screen submenu.
- 2) Press **cid/vol/^** or **redial/p/vol/v** to select **On** or **Off**.
- 3) Press the **OK** soft key. You will hear a confirmation tone.



The handsets have a variety of animation displays. Below are examples of the animation screens and what they mean:

Turning on the phone

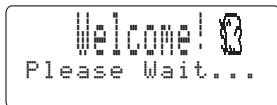

Hanging up the phone



Confirmation (Done!)



Deleting (Deleted!)



Find Handset/  
Paging the Handset



Also, the animation display changes depending on the ringer volume setting.

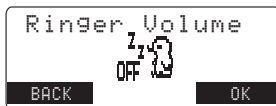

Out of Range



Unavailable



Low Battery

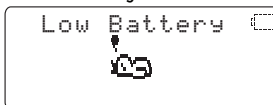

## Global Setup

If you change one of the global settings, you change that setting for all registered handsets. Only one handset can change global settings at a time.

## Setting Day and Time

Day & Time sets the day and time of your display.

- 1) Press the **MENU** soft key. Select the Global Setup menu, and then the Day & Time submenu option.
- 2) Press **cid/vol/^** or **redial/p/vol/v** to select the day of the week, and then the → soft key.
- 3) Press **cid/vol/^** or **redial/p/vol/v** to set hour, and then press the → soft key.
- 4) Press **cid/vol/^** or **redial/p/vol/v** to set minute, and then press the → soft key.
- 5) Press **cid/vol/^** or **redial/p/vol/v** to choose AM or PM, and then press the **SAVE** soft key. You will hear a confirmation tone.



note

If you do not press a key for two minutes, the phone will return to standby.



- Call Waiting Deluxe (CWDX) may not be supported by your phone service provider.
- If the area code already been stored in memory, the stored area code will be displayed. To change it, use the **DELETE** soft key and number keys to enter the new area code.

### Setting CIDCW (Caller ID on Call Waiting)

CIDCW sets the Caller ID on Call Waiting (CIDCW) displays the name and number of an incoming call while you are on the line.

- 1) Press the **MENU** soft key. Select the Global Setup menu, and then the CIDCW submenu.
- 2) Press **cid/vol/^** or **redial/p/vol/v** to select CW On/CWDX On, CW On/CWDX Off, or CW Off/CWDX Off, and then press the **OK** soft key. You will hear a confirmation tone.



### Setting the Area Code

If you enter a 3-digit area code number in the Area Code option, your local area code does not appear in the Caller ID message. For calls received from outside your local area code, you will see a full 10-digit number.

 If your calling area requires 10-digit dialing, do not program this option.

- 1) Press the **MENU** soft key. Select the Global Setup menu, and then the Area Code submenu.
- 2) Press the number keypad (**0-9**) to enter a 3-digit area code.
- 3) Press the **OK** soft key. You will hear a confirmation tone.

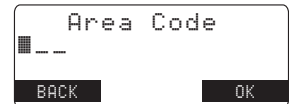

# Using Your Phone

## Calling with Packet8 service

- To call anywhere in the world, dial: country code + area code + number. For example, the country code for the U.S. and Canada is "1." To call anywhere within the US or Canada, dial: 1 + area code + number
- Anyone can call you at your Packet8 phone number.

## Using the Speakerphone

With the handset's duplex speakerphone, you can have hands-free conversations.

The  icon appears on the display screen during hands-free conversations.

You can easily switch a call from normal conversation to hands-free conversation. To switch a call, press  during the call.

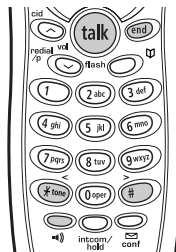

### For maximum range:

- Keep the antenna free of obstruction.
- When the handset is not in use place it in an upright position.
- Do not hold the handset where you would block the signal.

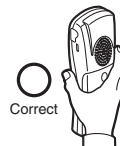

- Metal and reinforced concrete may affect cordless telephone performance.
- For best performance talk alternately with the caller in a quiet room. You can decrease the speaker volume if you or the other party has difficulty hearing.



- To set "AutoTalk", see page 22 or to set "Anykey Answer" see page 23.
- The handset microphone is located at the bottom of the handset (see "Controls and Functions" on page 5). Position yourself as near to the handset as possible and speak clearly.
- If the line is in use by another handset(s), "InUse" appears in the display of all registered handsets that are not in use.

## Making and Receiving Calls

	From the Handset	
	Normal	Speakerphone
To make a call	<b>Remove the handset from the cradle.</b> 1) Press <i>talk/flash</i> . 2) Listen for the dial tone. 3) Dial the number. <b>OR</b> Dial the number, and then press <i>talk/flash</i> .	<b>Remove the handset from the cradle.</b> 1) Press <b>Ⓜ</b> . 2) Listen for the dial tone. 3) Dial the number. <b>OR</b> Dial the number, and then press <b>Ⓜ</b> .
To answer a call	Pick up the handset and press <i>talk/flash</i> . (If Auto-talk is ON, the phone will automatically answer when you remove the handset from the cradle.)	Pick up the handset and press <b>Ⓜ</b> . (If Auto-talk is ON, the phone will automatically answer when you remove the handset from the cradle.)
To hang up	Press <b>end</b> or return the handset to the cradle (AutoStandby).	
To enter a pause within the dialing sequence	When you dial the number in standby mode, press <b>redial/p/vol/√</b> . <b>P</b> appears in the display, which represents a pause.	

## Call Waiting

If a call waiting tone sounds while you are on a call, press **talk/flash** on the handset to accept the waiting call. There is a short pause, and then you will hear the new caller. To return to the original caller, press **talk/flash** again.

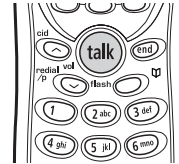

While a call is on hold, CIDCW can not be received.

## Placing a Call on Hold

You can place a call on hold for 5 minutes. When 5 minutes has passed, the call is disconnected, and the phone returns to standby mode.

- 1) During a call, press **intcom/hold**. The call will be put on hold.



If you leave a call on hold for more than 10 seconds, the display screen will read, Hold.

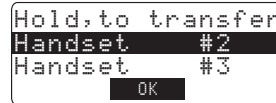

- 2) To talk to the caller, press **talk/flash** or **⏪** on a handset. The phone will return back to the call.



- If the number exceeds 32 digits, only the first 32 digits are retained in redial memory.
- If the redial memory is empty, you will hear a beep.

## Redialing a Call

The last three phone numbers dialed can be quickly redialed from the handset. Redial numbers stored in the handset are independent from each other.

- 1) With the phone in standby mode, press **redial/p/vol/v**.
- 2) Press **cid/vol/^** or **redial/p/vol/v** to scroll through the last three dialed numbers.
- 3) Press **talk/flash** or **Ⓜ** on the handset. The selected number is dialed.
- 4) To hang up, press **end**.

You can also display the redial list with the handset in talk mode. Press the **MENU** soft key, then select the redial menu. Press **cid/vol/^** or **redial/p/vol/v** to select the number you want to dial. Press the **DIAL** soft key to redial the number.

## Deleting a Redial Record

- 1) With the phone in standby mode, press **redial/p/vol/v**.
- 2) Press **cid/vol/^** or **redial/p/vol/v** repeatedly to display the number to be deleted.
- 3) Press the **EDIT** soft key.
- 4) Press **cid/vol/^** or **redial/p/vol/v** to choose Delete? and then press the **OK** soft key.
- 5) Press **cid/vol/^** or **redial/p/vol/v** to choose Yes.
- 6) Press the **OK** soft key. The redialed number is deleted.



## Storing a Redial Record

- 1) With the phone in standby mode, press **redial/p/vol/v**.
- 2) Press **cid/vol/^** or **redial/p/vol/v** repeatedly to display the number to be stored.
- 3) Press the **EDIT** soft key, then select **Store into PB?**, and then **OK** soft key.
- 4) To complete the setting, follow the steps 3-8 in "Phonebook (Storing Phone Numbers, Names, Distinctive Rings, and Speed dial)" on page 38-39.

## Adjusting the Earpiece and Speaker Volume

You can select from among six volume levels on the handset. Pressing the volume up key or volume down key during a call will change the earpiece or speaker volume. This setting will remain in effect after the telephone call has ended.

If you press the volume up key when the earpiece is at the maximum volume level, an error tone sounds. The error tone also sounds if you press the volume down key at the lowest volume.

## Temporarily Muting the Ringer

You can mute the ringer individually on a handset. When the phone is ringing, press **end** or the **MUTE** soft key on the handset you want to mute. This mute will last for the current incoming call only. The ringer tone will return to the previous setting on the next incoming call.

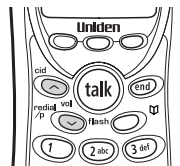

While charging a handset, you can not mute the ringer tone for the handset.

## Mute Microphone

You can temporarily mute the microphone so that the caller cannot hear you. Press the **MUTE** soft key during a call to mute the microphone. **Mute On** and  appear in the display. To cancel muting, press the **MUTE** soft key again. **Mute Off** appears.



## Privacy Mode

Privacy Mode prevents interruption from other registered handsets. **This works only when the phone is in use.**

- 1) Press the **MENU** soft key on the handsets during talk mode.
- 2) Press **cid/vol/^** or **redial/p/vol/v** to select Privacy Mode, and then the **OK** soft key.

**Privacy Mode On** and  appear in the display. To exit the Privacy Mode, simply repeat the same steps. **Privacy Mode Off** appears.



## Traveling Out of Range

During a call, as you begin to move your handset too far from your base unit, noise may increase. If you pass the range limits of the base unit, you will hear a beep and see **Out of Range** on the display, and then the handset returns to standby mode.

## Conferencing

If you have more than one handset, the phone permits 3-way conversations between 2 handsets and an outside line.

- 1) Initiate the call normally. Once the call is in progress, other people can join the call.
- 2) To join a conference call, press **talk/flash** or **Ⓜ** to use the handset speakerphone.
- 3) To leave a conference call, simply hang up as you normally would. All other parties will remain connected.
- 4) To end a conference call completely, all local parties must hang up. The conference call will also end when the calling party hang up.

## Find Handset

To locate the handset, press **find hs** on the base when the phone is in standby mode. All registered handsets beep for 60 seconds, and **Paging** appears on the handset display. To cancel paging, press any key on the handset or **find hs** on the base.



- If someone is using another handset in Privacy Mode, System Busy Please try later appears in the display when you try to join the call.
- If the battery pack is completely drained, the handset will not beep when paging.



The UIP160P's Voice Mail Tone is already configured to work with Packet8's system. Do not change the Voice Mail Tone setting.

## Using One Touch Voice Mail Access

The UIP160P provides one-touch access to Packet8's voice mail service. Follow the steps below to program the Packet8 access number into any handset(s):

- 1) Press the **MENU** soft key. Select the Handset Setup menu, and then the Edit Voice Mail submenu.  
Edit V\_mail No. appears.
- 2) Enter the Packet8 voice mail access number: 012-0555
- 3) Press the **OK** soft key.

To delete the current Voice Mail Access Number, delete all numbers in step2 using the **DELETE** soft key and the **OK** soft key.

When you have messages the New Message LED will flash. To retrieve your messages, simply press **☒/conf**. If you have not entered the access number or it has been deleted, when you press **☒/conf**. No Number Stored Store number in Menu Setup appears and you will hear a beep. The phone returns to standby mode.

### Resetting the New Message LED

If the LED remains on after you've retrieved your messages, you may need to reset the indicators. With the phone is in standby mode, press and hold **find hs** on the base until the paging sound stops (about 5 seconds).

# Phonebook (Storing Phone Numbers, Names, Distinctive Rings and Speed Dial)

You can store names and numbers in your phone's phonebook, search for names alphabetically, and dial phonebook entries with just a few key presses. You can store up to 100 numbers in each registered handset.

The phone uses the same memory to store phonebook entries and Caller ID messages. If the shared memory is already full, the phone will not store any more phonebook entries. You will have to delete some of the Caller ID messages before you can store a new phonebook entry.

- 1) When the phone is in standby mode, press  $\varnothing$  (phonebook).

The following items appear:

(2nd line) The number of the phonebook entries used

(3rd line) How to search (press the number keypad, *cid/vol/^* or *redial/p/vol/v*)

(4th line) The **COPY**, **STORE**, **DELETE** soft keys.

```

<Phonebook>
Total:100
Search[A-Z/↑/↓]
COPY  STORE  DELETE
  
```

- 2) Press the **STORE** soft key. Store/Edit Name appears.

- 3) Enter the name (up to 16 characters) by using the number keypad (see the "Steps for Entering Names and Special Characters" on page 40).

```

Store/Edit Name
Movies
BACK  DELETE  OK
  
```

If a name is not required, go to step 4. <No Name> will be used as the name.

note

When the memory is full, you will hear a beep and Memory Full appears.



- The pause key counts as one digit. Pressing **redial/p/vol/√** more than once increases the length of the pause between numbers. Each pause represents a 2 seconds delay.
- If you choose not to store a Distinctive Ring, simply select the "No Selectn" option.
- If you choose not to store the name/number as a Speed Dial, simply choose the "No Selectn" option.

- 4) Press the **OK** soft key to store the name; Store/Edit No. appears.
- 5) Use the number keypad, **\*/tone/<**, or **#/>** to enter the phone number (up to 20 digits).  
If you make an error, use the **DELETE** soft key to erase the incorrect digits. When you are finished, press the **OK** soft key to store the number.
- 6) Distinctive Ring appears. Press **cid/vol/^** or **redial/p/vol/√** to move the pointer to one of the Distinctive Ring options and then press the **OK** soft key.
- 7) Speed Dial appears. Press **cid/vol/^** or **redial/p/vol/√** to move the pointer to select the Speed dial location (10 locations: SPD1-SPD0).
- 8) Press the **OK** soft key. You will hear a confirmation tone, and Done! appears in the display.

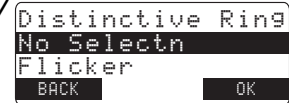

## Chain Dialing

The phonebook entries in the handset are not limited to phone numbers. You can also store a group of numbers (up to 20 digits) that you need to enter once your call connects. This is referred to as Chain Dialing.

An example of this is a bank account number. Store the account number in one of the phonebook entries (refer to "Phonebook (Storing Phone Numbers, Names, Distinctive Rings and Speed Dial)" on page 38). When you call your bank and are prompted to enter the account number, scroll through your phonebook entries until you find your account number, and then press the **DIAL** soft key.

## Steps for Entering Names and Special Characters

You can use the letters on the number keys to enter special characters. Each time you press a number key, the phone cycles through the available characters for that key in the following order: Upper case letters first, lower case letters next and finally the number corresponding to the key.

keys	Number of times key is pressed								
	1	2	3	4	5	6	7	8	9
1	1								
2 abc	A	B	C	a	b	c	2		
3 def	D	E	F	d	e	f	3		
4 ghi	G	H	I	g	h	i	4		
5 jkl	J	K	L	j	k	l	5		
6 mno	M	N	O	m	n	o	6		
7 pqrs	P	Q	R	S	P	q	r	s	7
8 tuv	T	U	V	t	u	v	8		
9 wxyz	W	X	Y	Z	w	x	y	z	9
0 oper	&	<	>	<	>	/	(blank)	--	--
	.	,	=	?	!	@	'	"	*
	#	0							



If the next character uses the same number key, you must press #/> to move the cursor over. Otherwise the next time you press the number key, it changes the character that was previously set.

For example, to enter **Movies**:

- 1) When the phone is in standby mode, press **☰** and the **STORE** soft key. *Store/Edit*  
*Name* appears.
- 2) Press **6** once, and then press **#/>** to move the cursor to the right. ("M")
- 3) Press **6** six times. ("o")
- 4) Press **8** six times. ("v")
- 5) Press **4** six times. ("i")
- 6) Press **3** five times. ("e")
- 7) Press **7** eight times. ("s")
- 8) When finished, press the **OK** soft key.

#### **If you make a mistake while entering a name**

Use **\*/tone/<** or **#/>** to move the cursor to the incorrect character. Press the **DELETE** soft key to erase the wrong character, and then enter the correct character. To delete all characters press and hold the **DELETE** soft key.

To continue to store the telephone number, proceed to step 5 in "Phonebook (Storing Phone Numbers, Names, Distinctive Rings, and Speed dial)" on page 39.

## Viewing the Phonebook

Your phone stores names/numbers in the phonebook memory entries, and you can search names in alphabetical order. You can view the phonebook even while the phone is in use.

- 1) Press **☰**.

If you recall the phonebook during a call, only the **BACK** soft key will appear.



- 2) Press **cid/vol/∧** or **redial/p/vol/∨**, or the number keypad to scroll through the phonebook entries. Phonebook entries appear in alphabetical order (from first to last when you press **redial/p/vol/∨**, from last to first when you press **cid/vol/∧**).

You can also use the letters on the number keys to select the first letter of the desired name. Press a number key (**2-9** and **0**) once for the first letter, twice for the second letter, and so on. The first entry that begins with the letter you entered appears.

For example, to jump to the first phonebook entry starting with the letter M, press **6** once. Press **cid/vol/∧** or **redial/p/vol/∨**, until the phonebook entry is displayed.

- 3) To finish the viewing operation, press **end** (or the **BACK** soft key or **talk/flash** during a call).

note

During a call, don't press **end** on the handset or the call will be disconnected.

## Making Calls Using the Phonebook

### From Standby Mode

- 1) When the phone is in standby mode, select the phonebook entry you want to dial (see "Viewing the Phonebook" on page 42).
- 2) Press **talk/flash** or **Ⓜ** on the handset. The displayed number is dialed.
- 3) To hang up, press **end** (or return the handset to the base).



Movies  
800-730-3456  
#Beethoven9/SPD1  
EDIT

### From Talk Mode

- 1) Press **talk/flash** or **Ⓜ**.
- 2) Select the phonebook entry you want to dial (see "Viewing the Phonebook" on page 42).
- 3) Press the **DIAL** soft key. The number in the displayed phonebook location is dialed.
- 4) To hang up, press **end** (or return the handset to the base).

### Speed Dialing

If you store a phone number in a speed dial memory location (10 locations: SPD1 - SPD0), you can use the speed dialing feature. When the phone is in standby mode, press and hold a number key (0-9) associated with the speed dial until the phone number appears, and then press **talk/flash** or **Ⓜ**. The number stored in the speed dial (SPD1 - SPD0) is dialed.

## Editing or Erasing a Phonebook Entry

- 1) When the phone is in standby mode, press  $\varnothing$ .
- 2) Press *cid/vol/*^ or *redial/p/vol/*√, or the number keypad to select the phonebook entries (see "Viewing the Phonebook" on page 42).



### a. Editing the Stored Data

- 1) When the phonebook entry to be edited appears, press the **EDIT** soft key, and then select Edit?. Store/Edit Name appears.
- 2) Follow the steps 3 to 7 under "Phonebook (Storing Phone Numbers, Names, Distinctive Rings, and Speed Dial)" on page 38-39 to complete the editing operation.
- 3) Press the **OK** soft key. You will hear a confirmation tone.



### b. Deleting the Stored Data

- 1) When the phonebook entry to be deleted appears, press the **EDIT** soft key, and then select Delete?. Delete Memory? appears.
- 2) Press *cid/vol/*^ or *redial/p/vol/*√ to move the pointer to Yes.
- 3) Press the **OK** soft key. You hear a confirmation tone. Deleted! appears in the display.





If the memory entry on the receiving handset is full, and can not store the phonebook entries, you will hear a beep.

## Copying Phonebook Entries

Copy Phonebook allows you to transfer stored phonebook entries from handset to handset so you don't have to manually re-enter names and numbers. You can transfer one memory (phonebook entry) at a time, or all memory entries at once.

- 1) When the phone is in standby mode, press  $\varnothing$ .
- 2) Press the **COPY** soft key.
- 3) Press **cid/vol/^** or **redial/p/vol/v**, to select the handset you want transfer the phonebook entries to and then press the **OK** soft key.
- 4) Press **cid/vol/^** or **redial/p/vol/v** to select One Memory or All Memories: and then press the **OK** soft key.

If you select All Memories, Are you sure? appears on the display screen.

Press **cid/vol/^** or **redial/p/vol/v** to select Yes, and then press the **OK** soft key.

If you select One Memory, press **cid/vol/^** or **redial/p/vol/v**, or the number key (2-9 and 0) to select the phonebook entry you want to export and then press the **COPY** soft key.

- 5) The phonebook entries will be transferred to the handset. Copying and the receiving handset name appear. When the transfer is completed Done! appears on the handset.

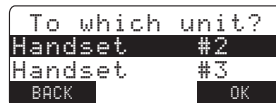

# Caller ID and CIDCW (Caller ID on Call Waiting)

When the telephone rings, the Caller ID feature allows you to view the caller's name, phone number, date and time of call. With CIDCW (Caller ID on Call Waiting), you will hear a call waiting tone while you are on a call, and the Caller ID data is displayed. To accept the waiting call, press **talk/flash** on the handset. Additionally, you can dial a number stored in the Caller ID list or save data to your phonebook entries.

## Important:

Memory locations for Caller ID messages and Phonebook entries (including Speed Dials) are common; you can store up to 100 entries for each handset. Caller ID messages are not stored when you have 100 phonebook entries. When you have stored a total of 100 phonebook entries and Caller ID messages, the oldest Caller ID message is overwritten.

The date and time received	12/21 12:30P *
Caller's name	Jane Smith
Caller's phone number	214-555-1234
	EDIT

- 1) When the Caller ID message is received, the display shows the caller's phone number along with the date and time. The incoming call information is stored in the Caller ID record. If the Caller ID service includes the caller's name, the name will appear in the display (up to 15 characters).



- Packet8 service comes with Caller ID and Call Waiting.
- If you answer a call before the Caller ID message is received (for example, before the second ring), the Caller ID message will not appear.
- When the call is received via a telephone company that does not offer Caller ID service, the caller's phone number and name does not appear. (This includes some international calls.)
- When the call is via a private branch exchange (PBX), the caller's phone number and name may not appear.



\* icon appears next to the time to indicate this is an unread message. Once you view the new message, the \* icon will disappear.

You may receive any one of the following messages:

When invalid data is received; Incomplete Data

When a private name is received; Private Name

When a private number is received; Private Number

When an unknown name is received; Unknown Name

When an unknown number is received; Unknown Number

2) When you pick up the phone, the display changes to Talk.  
(AutoTalk feature is set to on).



Data errors appear as "■."

### Viewing the Caller ID List

You can view the Caller ID list through the handset during a call or when the phone is in standby mode.

1) With the phone in standby mode, press **cid/vol/^**.  
With the phone in talk mode, press the **MENU** soft key.  
Use **cid/vol/^** and **redial/p/vol/v** to select Caller ID,  
then press the **OK** soft key.

The summary screen appears. The screen shows the number of new messages and total messages.

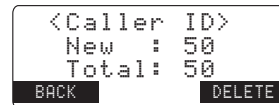

2) To view the Caller ID messages in historical order (from new to old or from old to new), repeatedly press **redial/p/vol/v** to scroll through the messages from the latest to the earliest, or **cid/vol/^** to scroll back through the messages.

To search the Caller ID messages alphabetically, press the number key pad (**2-9** and **0**) with the letter associated with the first letter of the desired caller.



Once you view the Caller ID list with alphabetical search, you cannot switch back to historical order (from new to old or from old to new) unless you exit and re-enter the operation.

- 3) To finish viewing the Caller ID list, press **end** (or the **BACK** soft key or **talk/flash** during a call).

### Deleting a Caller ID Record

- 1) When the phone is in standby mode, navigate to the Caller ID information to be deleted (see "Viewing the Caller ID List" on page 47).
- 2) Press the **EDIT** soft key, then select **Delete?**. **Delete Caller ID** appears.
- 3) Press **cid/vol/^** or **redial/p/vol/v** to choose **Yes**.
- 4) Press the **OK** soft key. You will hear a confirmation tone.

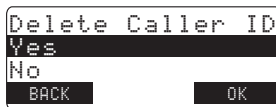

- During a call, don't press **end** on the handset or the call will be disconnected.
- Once the Caller ID data has been deleted, the information cannot be retrieved.

## Deleting All Caller ID names/numbers

- 1) When the phone is in standby mode, press **cid/vol/∧**. Press the **DELETE** soft key. Delete All? appears.

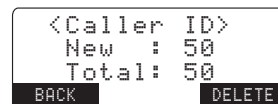

- 2) Press **cid/vol/∧** or **redial/p/vol/√** to choose Yes.



- 3) Press the **OK** soft key. You will hear a confirmation tone.

## Using the Caller ID Message List

### Calling a party from the Caller ID list

#### Standby mode

- 1) When the phone is in standby mode, select the desired Caller ID record (see "Viewing the Caller ID List" on page 47).
- 2) To have the phone dial a "1" before the displayed Caller ID number, press **\*/tone/<**. To have the phone dial the stored area code before the displayed Caller ID number, press **#/>**.
- 3) Press **talk/flash** or **Ⓜ**. The displayed phone number dials automatically.

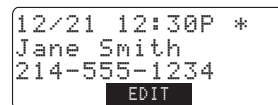

## Talk mode

- 1) When the phone is in talk mode, select the Caller ID record you want to dial (see "Viewing the Caller ID List" on page 47).
- 2) Press the **DIAL** soft key, and the number will be dialed.

## Storing Caller ID records in the Phonebook

Records shown in the Caller ID list can be stored in the phonebook. The phone number and name of the party listed on the Caller ID record can be stored in the phone book without reentry.

- 1) When the phone is in standby mode, select the Caller ID message to be stored. Press the **EDIT** soft key and use *volume up/down* to select *store into PB?*, and then press the **OK** soft key. *Store/Edit Name* appears. If the Caller ID message is already stored in memory, you will hear a beep and *This data is already stored!!* appears. The number will not be stored.
- 2) To complete the setting, follow the steps 3-8 in "Phonebook (Storing Phone Numbers, Names, Distinctive Rings, and Speed dial)" on page 38-39.



- When a long distance call has been set, "1" appears in the display.
- If the Caller ID message was received as a private/unknown number, or the message does not have the number, you cannot store the message in the phonebook. If it was received as private/unknown name, the message will be stored as <No Name>.
- If all 100 memory entries are full, the Caller ID message will be erased from Caller ID list when you store it in the phonebook.



Handsets can be in Direct Link mode while other handsets are in use.

## Multi-Handset Features

The features in this section require a minimum of two handsets to operate. To add additional handsets to your system, see "Expanding Your Phone" on page 13.

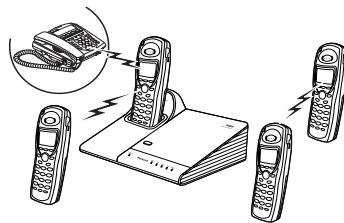

### Using the DirectLink Two-Way Radio Feature

With the DirectLink two-way radio feature, a pair of handsets can function as two-way radios. DirectLink Mode allows two handsets to communicate with each other without the base unit or a telephone line. Use them at sporting events or while shopping to stay in contact with family members or friends. You must set both handsets to DirectLink Mode to activate this feature.

#### Activating DirectLink Mode

- 1) Press the **MENU** soft key and select the DirectLink Mode menu. To enter DirectLink mode Press [ENTER] appears.
- 2) Press the **ENTER** soft key to enter DirectLink mode. You will hear a confirmation tone, and DirectLink Mode Complete appears.
- 3) To return to normal mode, press the **CANCEL** soft key and then the **OK** soft key, or return the handset to the cradle.

```
To enter  
DirectLink mode  
Press [ENTER]  
BACK ENTER
```

## Making a DirectLink Call

- 1) When the phone is in the DirectLink standby mode, press the **DirectLink** soft key (example of DirectLink from handset #1).
- 2) Select the handset to which you wish to DirectLink with by pressing the number keys (**0-9**). Your handset will then page the selected handset.
- 3) On the receiving handset, press **talk/flash**, the **ANSWER** soft key, or if Any Key Answer is on, press any number key, **\*/tone/**<, or **#/**>.
- 4) When you finish your conversation, press **end** or the **END** soft key on either handset. Return the handset to the cradle, or press the **CANCEL** soft key and then the **OK** soft key to return to normal standby mode (cancelling DirectLink mode).

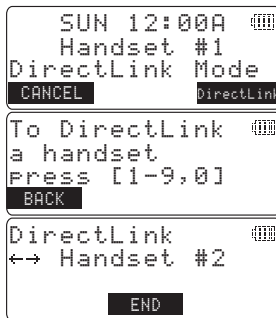



This feature only works when the handset(s) is within the range of the base.

## Using the Room/Baby Monitor

This feature allows you to monitor sounds in another room. Place a handset in the room you wish to monitor; it will function as a microphone. A second handset can be set to function as a remote speaker, allowing you to monitor sounds in the room.

- 1) Press the **MENU** soft key and select the Room Monitor menu.
- 2) Select the handset you want to monitor by using **cid/vol/∧** or **redial/p/vol/∨**.
- 3) Press the **OK** soft key.  
Monitoring appears, and you hear sounds in the room where the handset is installed.
- 4) To turn off the Room Monitor, press the **END** soft key, or **end**.

If you want to prevent other handsets from monitoring this one, press the **MENU** soft key. Select the Handset Setup menu, and then the Room Monitor submenu. Select **Off** and press the **OK** soft key.

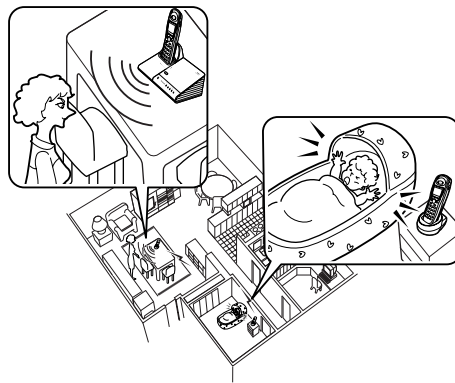

## Using the Intercom

If you have two or more handsets, you can use them as an intercom.

- 1) In standby mode, press **intcom/hold**.
- 2) Select the handset you want to talk with within 30 seconds. To select the handset, press **cid/vol/∧** or **redial/p/vol/∨**, and then press the **OK** soft key. If you select #11, all other handsets will be paged. An intercom tone sounds.

```
To intercom
Handset #2
Handset #3
OK
```

- To cancel intercom, press the **CANCEL** soft key on the initiating handset.
- 3) To answer the page, press **talk/flash, intcom/hold**, or the **ANSWER** soft key. If Any Key Answer is enabled, pressing a number key, **\*/tone/<**, or **#/>** will answer the page. If AutoTalk is enabled, you can answer the page by simply picking up the handset.
  - 4) To hang up the intercom call, press **end** or the **END** soft key on either handset.

```
Intercom
←← Handset #1
ANSWER
```



If the party is busy or out of range, the handset returns to standby mode.



- If any you receive an outside/intercom call or page while selecting the other handset, the operation will be cancelled.
- If the party does not answer within one minute, the operation is cancelled.

## Transferring a Call

You can transfer an outside call to another handset.

- 1) During a call, press **intcom/hold** on the handset.
- 2) Select a handset to transfer the call to within 10 seconds.

To select the handset, press **cid/vol/^** or **redial/p/vol/v**, and then press the **OK** soft key. If you select **All**, all other handsets will be paged.

The call will automatically be placed on hold, and an intercom tone sounds. To cancel the transfer, press the **CANCEL** soft key, **talk/flash** or **Ⓜ** on the initiating handset.

- 3) To answer the page on a handset, press **talk/flash**, **intcom/hold**, or the **ANSWER** soft key. If Any Key Answer is enabled, pressing any number key, **\*/tone/<**, or **\*/>** will answer the page. If AutoTalk is enabled, you can answer the page by simply picking up the handset.
- 4) To speak to the caller, press **talk/flash** on the receiving handset.

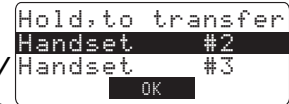

# Troubleshooting

If your phone is not performing to your expectations, please try these simple steps first. If these steps do not solve your problem, please call our Customer Service Hotline at 1-800-297-1023. (Mon - Fri 7 am to 7 pm, Sat/Sun 9 am to 5 pm, CST. The Customer Service Hotline is closed on holidays.)

## Getting Help

### **If you have trouble connecting to your VoIP Service**

Contact Packet8 customer service at **1-888-898-8733** or visit [www.packet8.net/support](http://www.packet8.net/support).

### **If you have questions about using your VoIP service features.**

Contact Packet8 customer service at **1-888-898-8733** or visit [www.packet8.net/support](http://www.packet8.net/support).

### **If you have questions on how to use your phone, add extra handsets, program the phonebook, etc.**

Contact Uniden customer service at 800-554-7331, Monday-Friday, 8 am to 5 pm, CST, or visit the Uniden website at [www.uniden.com/voip](http://www.uniden.com/voip) for documentation, FAQs, and troubleshooting tips.

## Installation Troubleshooting

### Understanding the LED Indicators

If you're having trouble with your UIP160P, the LEDs on the front panel can help identify the problem. Figure 1 shows the location of the LEDs, and Table 1 lists the states of the LEDs and what they mean.

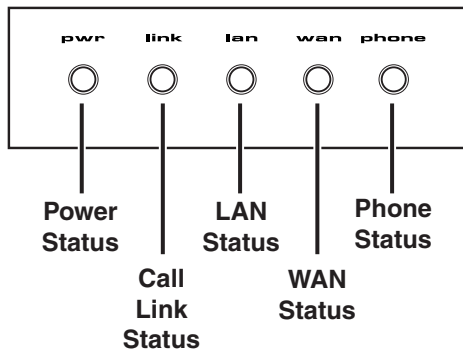

### LED States and Their Meaning

LED	On	Off	Blinking
Power	The UIP160P has power.	The UIP160P has no power.	NA
Link	The UIP160P has registered with Packet8.	The UIP160P has not resgisted with Packet8 service.	NA
LAN	The UIP160P detects a valid link on its LAN port.	The UIP160P cannot detect a valid link.	The UIP160P is receiving data on its LAN port.

LED	On	Off	Blinking
WAN	The UIP160P detects a valid link on its WAN port.	The UIP160P cannot detect a valid link.	The UIP160P is receiving data on its WAN port.
Phone	The telephone connected to this port is in use or off hook.	The connected phone is on hook (not in use).	Fast: There is an incoming call. Slow: There is a message waiting.



While the UIP160P is downloading a firmware update or a new configuration file from Packet8, the LEDs will blink several times.

## Resetting the UIP160P

There are two ways to reset the UIP160P: a *power cycle* restarts the unit, and a *hard reset* restores the unit to factory defaults.

### Power Cycle

Simply unplug the telephone UIP160P and plug it in again. This restarts the UIP160P and reloads the configuration file.

### Hard Reset

A hard reset restores the UIP160P to factory defaults. All configuration changes will be lost.

**A:** Unplug the UIP160P's AC adapter.

**B:** Insert a pin or bent-out paper clip into the **RESET** hole on the rear of the UIP160P and push the reset button.

**C:** While holding the reset button pushed in, reconnect the UIP160P's AC adapter.

**D:** Hold the reset button for ten seconds and then release it. This sets the UIP160P main base back to factory defaults.

## Local Area Reset

Many problems can be solved by resetting all the local network equipment. To perform a local area reset, first power down all your local equipment: your modem, switch or router, UIP160P and computer. Then, restore power to the devices one at a time, starting with the one directly connected to the Internet and working your way down:

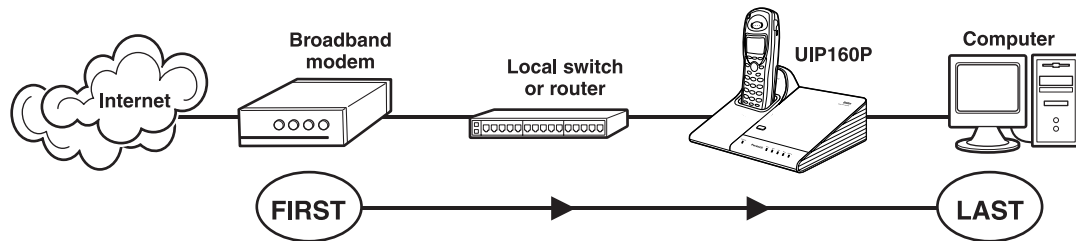

If a local area reset does not restore connectivity, see Common Issues below.

## Logging into the UIP160P

If you need to configure the UIP160P's router features or check settings while troubleshooting, you can log into the UIP160P directly from your web browser.

- A:** Make sure your computer is directly connected to the UIP160P's LAN port.
- B:** Open an Internet Explorer browser window.
- C:** In the address line of the browser, type **192.168.88.1** and press **ENTER**.
- D:** Enter "admin" in the password field and press **ENTER**.

See the User Interface Guide at [www.uniden.com/voip](http://www.uniden.com/voip) for more information.

## Common Issues For Terminal Adapter Features

Scenario	Check to see if...	Then try...
Your UIP160P is unable to connect to the Internet.	The PWR LED on the UIP160P is off, or the power LED on your modem is off.	1) Checking the power connection to the UIP160P, or your modem.
	The WAN LED on the UIP160P is off and/or the LAN LED on your modem is off.	Making sure the cable between the UIP160P and your modem is 1) Securely connected to the UIP160P's WAN port. 2) Securely connected to your modem's LAN port 3) Free of any frays, loose connectors, or other visible defects
	The UIP160P doesn't have a valid IP address. (Login to the UIP160P and check the WAN Status screen.)	1) Making sure the UIP160P is configured for DHCP or PPPoE (if your ISP uses DHCP or PPPoE). OR 1) Making sure the first three parts of the UIP160P's IP address match you ISP's IP address and the fourth part is different 2) Making sure UIP160P's subnet mask exactly matches the subnet mask of you ISP. OR 1) Making sure the UIP160P's default gateway address is set to your ISP's IP address.

Scenario	Check to see if...	Then try...
Your computer is unable to connect to the Internet.	The LAN LED on the UIP160P is off and/or the LINK LED on your computer's Ethernet card is off.	Making sure the cable between the UIP160P and your computer is 1) Securely connected to the UIP160P's LAN port. 2) Securely connected to your computer's Ethernet card 3) Free of any frays, loose connectors, or other visible defects
	Your computer doesn't have an IP address. (In most Windows systems, open a command prompt window and enter the command <i>ipconfig</i> .)	1) Making sure your computer is configured for DHCP. 2) Making sure the UIP160P's DHCP Server is enabled.
	Your computer's IP address and subnet mask are on a different network than the UIP160P's.	1) Making sure the first three parts of your computer's IP address match the UIP160P's IP address and the fourth part is different 2) Making sure your computer's subnet mask exactly matches the subnet mask of the UIP160P.
	The UIP160P is not the default gateway for your computer.	1) Making sure your computer's default gateway address is set to the UIP160P's IP address.
Your UIP160P handset has no dial tone.	The CA (call agent) LED is off.	1) Resetting the UIP160P. 2) Contacting Packt8 to verify the necessary SIP configuration settings.
	The CA (call agent) LED is on.	1) Plugging a standard analog phone into the UIP160P's VoIP1 port. If this works, your UIP160P may be damaged. Contact Uniden customer service.

## For Telephone Features

Symptom	Suggestion
The <b>charge</b> LED won't illuminate when the handset is placed in the cradle.	<ul style="list-style-type: none"> <li>• Make sure the AC adapter is plugged into the base or the charger (if you have more than one handset) and wall outlet.</li> <li>• Make sure the handset is properly seated in the cradle.</li> <li>• Make sure the charging contacts on the handset are clean.</li> </ul>

Symptom	Suggestion
The audio sounds weak.	<ul style="list-style-type: none"> <li>• Move the handset and/or base away from metal objects or appliances and try again.</li> <li>• Make sure that you are not too far from the base.</li> </ul>
Can't make or receive calls.	<ul style="list-style-type: none"> <li>• Check both ends of the base telephone line cord.</li> <li>• Make sure the AC adapter is plugged into the base and wall outlet.</li> <li>• Disconnect the AC adapter for a few minutes, and then reconnect it.</li> <li>• De-register the handset (see "De-register the Handset" on page 15) and register the handset (see "Register the Handset" on page 14).</li> <li>• Make sure that you are not too far from the base.</li> <li>• Make sure the line is not in use.</li> <li>• If an outside call is already established, you can not make another outside call.</li> </ul>
The handset doesn't ring or receive a page.	<ul style="list-style-type: none"> <li>• Charge the batteries in the handset for 15-20 hours by placing the handset on the base or charging cradle.</li> <li>• Make sure that you are not too far from the base.</li> <li>• De-register the handset (see "De-register the Handset" on page 15) and register the handset (see "Register the Handset" on page 14).</li> </ul>
Unavailable appears in the display.	<ul style="list-style-type: none"> <li>• Make sure that another handset(s) is not in use, and try the phone again.</li> <li>• Make sure that you are not too far from the base.</li> </ul>
Severe noise interference.	<ul style="list-style-type: none"> <li>• Keep the handset away from microwave ovens, computers, remote control toys, wireless microphones, alarm systems, intercoms, room monitors, fluorescent lights, and electrical appliances.</li> <li>• Move to another location or turn off the source of interference.</li> </ul>
Caller ID does not display.	<ul style="list-style-type: none"> <li>• The handset was picked up before the second ring.</li> <li>• The call was placed through a switchboard.</li> <li>• Contact your service provider to verify the Caller ID settings. There can be a problem with your Caller ID service.</li> </ul>

Symptom	Suggestion
You cannot register the handset at the base.	<ul style="list-style-type: none"> <li>• Charge the battery pack for 15-20 hours.</li> <li>• De-register the handset (see "De-register the Handset" on page 15) and register the handset (see "Register the Handset" on page 14).</li> </ul>
The handset doesn't communicate with other handsets.	<ul style="list-style-type: none"> <li>• De-register the handset (see "De-register the Handset" on page 15) and register the handset (see "Register the Handset" on page 14).</li> <li>• Make sure that you have registered all handsets.</li> </ul>
The handset can't join the conversation	<ul style="list-style-type: none"> <li>• Make sure there are not 2 handsets already using conference feature.</li> <li>• Make sure that another handset is not in privacy mode.</li> </ul>
Room Monitor feature does not work.	<ul style="list-style-type: none"> <li>• Make sure to place the handset(s) within the range of the base.</li> </ul>
If you still have a problem.	<ul style="list-style-type: none"> <li>• Call our customer hotline at 1-800-297-1023.</li> </ul>

# Note on Power Sources

## Battery replacement and handling

When the operating time becomes short, even after a battery is recharged, please replace the battery. With normal usage, your battery should last about one year. Please contact your place of purchase or the Uniden Parts Department for a replacement battery.

## Warning

To avoid the risk of personal injury or property damage from fire or electrical shock, only use the Uniden battery model and Uniden adapter model specifically designated for this product.

## Power Failure

During the period that the power is off, you will not be able to make or receive calls with the telephone.

### Caution

- Use only the specified Uniden battery pack (BT-446).
- Do not remove the batteries from the handset to charge them.
- Never throw the battery into a fire, disassemble them, or heat them.
- Do not remove or damage the battery casing.



Even when the battery pack is not being used, it will gradually discharge over a long period of time. For optimum performance, be sure to return the handset to the base unit after each telephone call.

## Battery Life

With average use, the battery should give you about 5 hours of talk time and 7 days of standby time. For optimum performance, return the handset to the cradle when it is not in use.

### Low battery alert

When the battery pack is very low, the phone is programmed to eliminate functions in order to save power.

The battery pack needs to be charged when:

- The empty battery icon appears.
- Low Battery appears in the display.

If the phone is in standby mode, none of keys will operate. If you are on a call, complete your conversation as quickly as possible, and return the handset to the cradle.

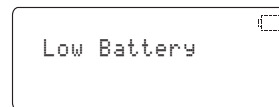

### Cleaning the battery charging contacts

To maintain a good charge, it is important to clean the charging contacts on the handset once a month. Using water only, dampen a cloth to clean the charging contacts. Then make sure to go back over the charging contacts with a dry cloth before returning the handset to the base to charge.

**Caution:** Do not use paint thinner, benzene, alcohol, or other chemical products. Doing so can discolor the surface of the telephone and damage the finish.



# General Information

The phone complies with FCC Parts 15. Operating temperature:  
0 °C to +50 °C (+32 °F to +122 °F)

## AC Adapter Information

AC Adapter part number: AD-1005 for the base  
Input Voltage: 100-240 AC 50/60Hz  
Output Voltage: 12V DC 1000mA

## Battery Information

Battery part number: BT-446  
Capacity: 800mAh, 3.6V



- To avoid damage to the phone use only Uniden AD-1005 and BT-446 with your phone.
- If the handset is left off of the base, the actual Talk mode duration will be reduced respective to the amount of time the handset is off the base.

Recharge your phone on a regular basis by returning the handset to the base after each phone call. When the operating time becomes short even after the battery is recharged, please replace the battery. With normal usage, the battery should last about one year.

A replacement Uniden adapter or battery can be purchased by contacting the Uniden Parts Department (see back page).

Specifications, features, and availability of optional accessories are all subject to change without prior notice.

# Liquid Damage

Moisture and liquid may damage your cordless phone. Follow the steps below if your phone gets wet:

Case	Action
If the exterior plastic housing on the handset or base is exposed to moisture or liquid.	Wipe off the liquid, and use as normal.
If moisture or liquid has entered the plastic housing (i.e. liquid can be heard in the phone or liquid has entered the handset battery compartment or vent openings on the base).	<p><b>Handset:</b></p> <ol style="list-style-type: none"><li>1) Remove the battery cover and leave it off for ventilation.</li><li>2) Disconnect the battery pack. Leave the battery cover off and the battery pack disconnected for at least 3 days.</li><li>3) Once the handset is completely dry, reconnect the battery pack and the battery cover.</li><li>4) Recharge the handset's battery pack for 20 hours before using.</li></ol> <p><b>Base:</b></p> <ol style="list-style-type: none"><li>1) Disconnect the AC adapter from the base, cutting off electrical power.</li><li>2) Disconnect the telephone cord from the base.</li><li>3) Let dry for at least 3 days.</li></ol> <p><b>IMPORTANT:</b> You must <b>unplug the telephone line while recharging the battery packs</b> to avoid charge interruption.</p> <p><b>CAUTION:</b> DO NOT use a microwave oven to speed up the drying process. This will cause permanent damage to the handset, base and the microwave oven. After following these steps, if your cordless telephone does not work, please call our Customer Service Hotline at 1-800-297-1023.</p>

## Precautions!

Before you read anything else, please observe the following:

### Warning!

Uniden America Corporation DOES NOT represent this unit to be waterproof. To reduce the risk of fire, electrical shock, or damage to the unit, DO NOT expose this unit to rain or moisture.

### Rechargeable Nickel-Metal-Hydride Battery Warning

- This equipment contains a rechargeable Nickel-Metal-Hydride battery.
- Nickel is a chemical known to state of California to cause cancer.
- The rechargeable Nickel-Metal-Hydride battery contained in this equipment may explode if disposed of in a fire.
- Do not short-circuit the battery.
- Do not charge the rechargeable Nickel-Metal-Hydride battery used in this equipment in any charger other than the one designed to charge this battery as specified in the owner's manual. Using another charger may damage the battery or cause the battery to explode.

### Rechargeable Nickel-Metal-Hydride Batteries Must Be Recycled or Disposed of Properly



The exclamation point within an equilateral triangle is intended to alert the user to the presence of important operating and maintenance (servicing) instructions in the literature accompanying the appliance.

Uniden works to reduce lead content in our PVC coated cords in our products and accessories.

### Warning!

The cords on this product and/or accessories contain lead, a chemical known to the State of California to cause birth defects or other reproductive harm. **Wash hands after handling.**

## Important Safety Instructions

When using your telephone equipment, basic safety precautions should always be followed to reduce the risk of fire, electric shock and injury to persons, including the following:

1. Do not use this product near water, for example, near a bathtub, wash bowl, kitchen sink or laundry tub, in a wet basement or near a swimming pool.
2. Avoid using a telephone (other than a cordless type) during an electrical storm. There may be a remote risk of electric shock from lightning.
3. Do not use the telephone to report a gas leak in the vicinity of the leak.
4. Use only the power cord and batteries indicated in this manual. Do not dispose of batteries in a fire. They may explode. Check with local codes for possible special disposal instructions.

### SAVE THESE INSTRUCTIONS

CAUTION: Risk of explosion if battery is replaced by an incorrect type. Dispose of used batteries according to the instructions.

## The FCC Wants You To Know

Should you experience trouble with this equipment, please contact Uniden customer service at 800-297-1023.

Changes or modifications to this product not expressly approved by Uniden, or operation of this product in any way other than as detailed by the owner's manual, could void your authority to operate this product. This device complies with part 15 of the FCC rules. Operation is subject to the following two conditions: (1) This device may not cause harmful interference, and (2) This device must accept any interference received, including interference that may cause undesired operation. Privacy of communications may not be ensured when using this phone. To insure the safety of users, the FCC has established criteria for the amount of radio frequency energy various products may produce depending on their intended usage. This product has been tested and found to comply with the FCC's exposure criteria. For body worn operation, the FCC RF exposure guidelines were also met when used with the Uniden accessories supplied or designed for this product. Use of other accessories may not ensure compliance with FCC RF exposure guidelines and should be avoided.

## One Year Limited Warranty

Important: Evidence of original purchase is required for warranty service. WARRANTOR: UNIDEN AMERICA CORPORATION ("Uniden") ELEMENTS OF WARRANTY: Uniden warrants, for one year, to the original retail owner, this Uniden Product to be free from defects in materials and craftsmanship with only the limitations or exclusions set out below.

WARRANTY DURATION: This warranty to the original user shall terminate and be of no further effect 12 months after the date of original retail sale. The warranty is invalid if the Product is (A) damaged or not maintained as reasonable or necessary, (B) modified, altered, or used as part of any conversion kits, subassemblies, or any configurations not sold by Uniden, (C) improperly installed, (D) serviced or repaired by someone other than an authorized Uniden service center for a defect or malfunction covered by this warranty, (E) used in any conjunction with equipment or parts or as part of any system not manufactured by Uniden, or (F) installed or programmed by anyone other than as detailed by the owner's manual for this product.

STATEMENT OF REMEDY: In the event that the product does not conform to this warranty at any time while this warranty is in effect, warrantor will either, at its option, repair or replace the defective unit and return it to you without charge for parts, service, or any other cost (except shipping and handling) incurred by warrantor or its representatives in connection with the performance of this warranty. Warrantor, at its option, may replace the unit with a new or refurbished unit. THE LIMITED WARRANTY SET FORTH ABOVE IS THE SOLE AND ENTIRE WARRANTY PERTAINING TO THE PRODUCT AND IS IN LIEU OF AND EXCLUDES ALL OTHER WARRANTIES OF ANY NATURE WHATSOEVER, WHETHER EXPRESS, IMPLIED OR ARISING BY OPERATION OF LAW, INCLUDING, BUT NOT LIMITED TO ANY IMPLIED WARRANTIES OF MERCHANTABILITY OR FITNESS FOR A PARTICULAR PURPOSE. THIS WARRANTY DOES NOT COVER OR PROVIDE FOR THE REIMBURSEMENT OR PAYMENT OF INCIDENTAL OR CONSEQUENTIAL DAMAGES. Some states do not allow this exclusion or limitation of incidental or consequential damages so the above limitation or exclusion may not apply to you.

LEGAL REMEDIES: This warranty gives you specific legal rights, and you may also have other rights which vary from state to state. This warranty is void outside the United States of America and Canada. PROCEDURE FOR OBTAINING PERFORMANCE OF WARRANTY: If, after following the instructions in the owner's manual you are certain that the Product is defective, pack the Product carefully (preferably in its original packaging). Disconnect the battery from the Product and separately secure the battery in its own separate packaging within the shipping carton. The Product should include all parts and accessories originally packaged with the Product. Include evidence of original purchase and a note describing the defect that has caused you to return it. The Product should be shipped freight prepaid, by traceable means, to warrantor at:

Uniden America Service  
4700 Amon Carter Blvd.  
Fort Worth, TX 76155

# I.C. Notice

## **RADIO EQUIPMENT**

The term "IC:" before the radio certification number only signifies that Industry Canada technical specifications were met.

Operation is subject to the following two conditions: (1) this device may not cause interference, and (2) this device must accept any interference, including interference that may cause undesired operation of the device. "Privacy of communications may not be ensured when using this telephone".

# Index

## Numerics

20 ring options . . . . . 21

3-Way Conferencing . . . . . 36

## A

Animation screen . . . . . 26

Anykey Answer . . . . . 23

Area Code . . . . . 29

AutoTalk . . . . . 22

## B

Banner . . . . . 23

Battery

    Preparing . . . . . 12

    Replacement and handling . . . . . 64

Beltclip . . . . . 16

## C

Call transfer feature . . . . . 55

Caller ID

    Call Waiting . . . . . 32

    Calling . . . . . 49

    CIDCW . . . . . 46

    Deleting . . . . . 48

    Setting . . . . . 29

    Storing . . . . . 50

    Viewing . . . . . 47

Chain dialing . . . . . 39

Clock . . . . . 28

Contrast . . . . . 24

Copying phonebook . . . . . 45

## D

De-register the handset . . . . . 15

DirectLink . . . . . 51

Distinctive ringer . . . . . 22

## E

Earpiece volume . . . . . 34

Expanding your phone . . . . . 13

## G

General information . . . . . 66

Global Setup . . . . . 28

## H

Hands-free conversation . . . . . 30

Headset installation . . . . . 16

Hold . . . . . 32

## I

I.C. notice . . . . . 69

Intercom . . . . . 54

## K

Key touch tone . . . . . 25

## L

Language . . . . . 24

Liquid damage . . . . . 67

## M

Making a call . . . . . 31

Mute . . . . . 35

## P

Page . . . . . 36

Phonebook

    Editing . . . . . 44

    Erasing . . . . . 44

    Making calls . . . . . 43

    Storing . . . . . 38

    Viewing . . . . . 42

Precautions . . . . . 68

Privacy Mode . . . . . 35

## R

Receiving a call . . . . . 31

Redialing a call . . . . . 33

Register the handset . . . . . 14

Ringer

    Adjusting . . . . . 34

Room/baby monitor . . . . . 53

## S

Setting up

    extra handset . . . . . 14

    Handset . . . . . 12, 20

    Menu options . . . . . 20

Soft Key . . . . . 18

Speed dialing . . . . . 43

## T

Transferring a call . . . . . 55

## V

Voice Mail Access . . . . . 37

## W

Warranty . . . . . 68

# Main Menu Flow Chart

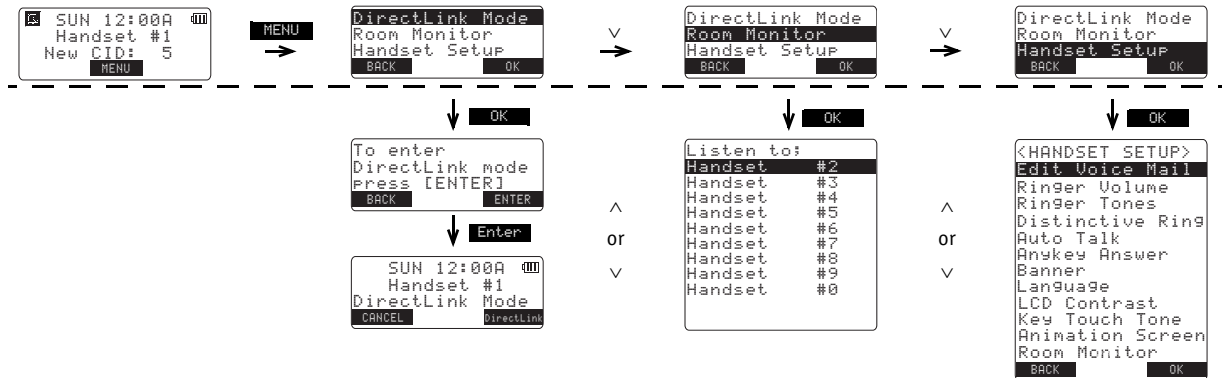

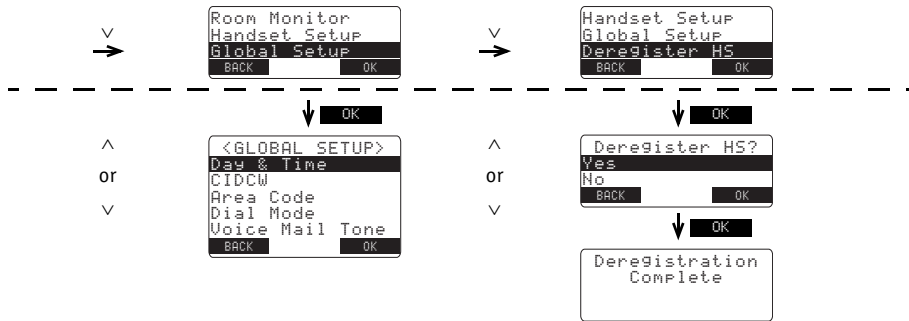

## At Uniden, we'll take care of you!

Thank you for purchasing a Uniden product. If you have any questions or problems,  
**please do not return this product to the place of purchase.**

### If you have trouble connecting to your VoIP Service or have questions about your VoIP service features

Contact Packet8 customer service at **1-888-898-8733** or visit [www.packet8.net/support](http://www.packet8.net/support).  
**If you have questions on how to use your phone, add extra handsets, program the phonebook, etc.**  
Contact Uniden customer service at 800-554-7331, Monday-Friday, 8 am to 5 pm, CST, or visit the Uniden website at [www.uniden.com](http://www.uniden.com) for documentation, FAQs, and troubleshooting tips.



### Need a Part?

To order headsets, additional handsets, replacement batteries or other accessories, visit our website at [www.uniden.com](http://www.uniden.com) or call 1-800-554-3988, Mon-Fri, 8 a.m. to 5 p.m. CST.



### Help for our Special Needs Customers

If you need special assistance due to a disability or have questions on the accessibility features of this product, please call **1-800-874-9314 (voice or TTY)**



# Uniden®

May be covered under one or more of the following U.S. patents:

4,797,916	5,381,460	5,426,690	5,434,905	5,491,745	5,493,605
5,533,010	5,574,727	5,581,598	5,650,790	5,660,269	5,661,780
5,663,981	5,671,248	5,696,471	5,717,312	5,732,355	5,754,407
5,758,289	5,768,345	5,787,356	5,794,152	5,801,466	5,825,161
5,864,619	5,893,034	5,912,968	5,915,227	5,929,598	5,930,720
5,960,358	5,987,330	6,044,281	6,070,082	6,125,277	6,253,088
6,314,278	6,418,209	6,618,015	6,671,315	6,714,630	6,782,098
6,788,920	6,788,953	6,839,550	6,889,184	6,901,271	6,907,094
6,914,940					

Other patents pending.



FOR  
ACCESSORIES,  
GO ONLINE @  
WWW.UNIDEN.COM

**REGISTER ONLINE TODAY!**

**THANK YOU FOR BUYING A UNIDEN PRODUCT.**

A World Without Wires | **Uniden®**