

Uniden®

OCEANUS DSC SERIES VHF MARINE RADIO WITH DIGITAL SELECTIVE CALLING



WIRELESS MICROPHONE CAPABILITY!

Works with up to two wireless mic accessories, optional WHAM and WHAM2 (not included).



OWNER'S MANUAL

Maritime Radio Services Operation

Warning!

This transmitter will operate on channels/frequencies that have restricted use in the United States. The channel assignments include frequencies assigned for exclusive use of the U.S. Coast Guard, use in Canada, and use in international waters. Operation in these frequencies without proper authorization is strictly forbidden. For frequencies/channels that are currently for use in the U.S. without an individual license, please contact the FCC Call Center at 1-888-CALL-FCC.

For individuals requiring a license, such as commercial users, you should obtain a license application from your nearest FCC field office.

Contents

Uniden OCEANUS DSC	2
Included with your OCEANUS DSC	3
Controls and Indicators	4
Installation	8
Choosing a Location	8
Engine Noise Suppression	9
Antenna Considerations	9
Antenna Selection and Installation	9
Installing the OCEANUS DSC	10
Operation	11
Power On/Off	11
Last Channel Memory	11
Squelch	12
Coast Guard Channel 16/Channel 9 Communications	13
Triple Watch	13
Manual Tuning	14
Weather Channels	14
MEM (Entering channel numbers into Memory Scan)	14
Triple Watch Scan	15
Normal Scan	15
Triple Watch Alert Scan	15
Alert Scan	15
Weather Alert	16
Transmitting	18
Setting TX Output	18
Distress	19
Marine Distress Procedure	20
Menu Operation	21
Digital Selective Calling (DSC)	21
Individual	21
Group	22
All Ships	23
Position Request	24
Position Send	26
Standby	27
Call Wait	28
Geographical Call	29

Setup	30
Alarm Clock	30
Directory	33
FIPS	37
Auto Channel Switch	40
Position Reply	41
CH Tag	43
WHAM	45
Group MMSI	48
User MMSI	49
System	51
Contrast	51
Lamp Adjust	52
Key Beep	53
NMEA Technical Setup	54
Optional Accessories	54
VHF FM Marine Radio Telephone	
Channel and Functions (USA Channels)	55
Channel and Functions (International Channels)	56
Channel and Functions (Canadian Channels)	57
NWR-SAME Event Code	58
Specification	59
Troubleshooting	60
Care and Maintenance	61
Three Year Limited Warranty	64

Uniden OCEANUS DSC

The Uniden **OCEANUS DSC** VHF marine radio has been designed to give you a rugged, reliable instrument that will provide you with years of trouble-free service.

With proper care and maintenance, your marine radio could outlast your present vessel and serve you well on-board. The full features and flexibility designed into this quality transceiver will prevent it from becoming obsolete regardless of changes in craft or geographic locations.

The technical excellence of this marine radio is demonstrated by the multiplicity of uses for which it has been found acceptable by the U.S. Federal Communications Commission. It is acceptable for compulsory use on "party boats", for use on vessels subject to the Great Lakes Radio Agreement or bridge-to-bridge requirements, for general pleasure and commercial vessels, and certain land stations in marine service.

The **OCEANUS DSC** is of all solid-state design with conservatively rated, rugged components and materials compatible with the marine environment. The transceiver utilizes a number of gaskets, sealing rings, waterproof membranes, and other sealants to effect a waterproof housing for protection of the electronics. It meets the most stringent JIS7 waterproof specification. The unit may be mounted in any number of convenient locations on your vessel by utilizing the optional universal mounting bracket (White - FMB322W, Black - FMB322B).

You are encouraged to thoroughly read the rest of this Operating Guide to acquaint yourself with the characteristics and operation of your transceiver so that you can contribute to the longevity of your investment.

Keep your receipt as proof-of-purchase in case warranty service is required.

Features, specifications, and availability of optional accessories are all subject to change without notice.

Note: **OCEANUS DSC** meets JIS7 requirements.

The color of your **OCEANUS DSC** may vary.

Included with your OCEANUS DSC

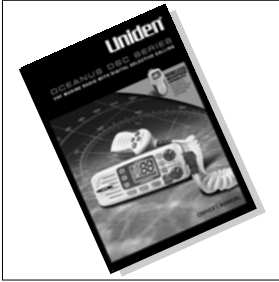

OCEANUS DSC
Owner's Manual

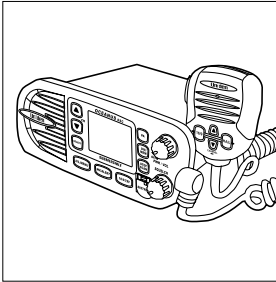

OCEANUS DSC Radio

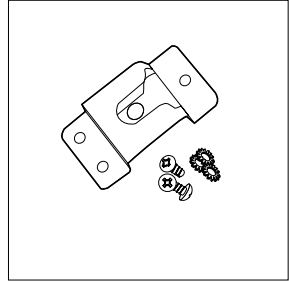

Microphone Hanger
and Screws

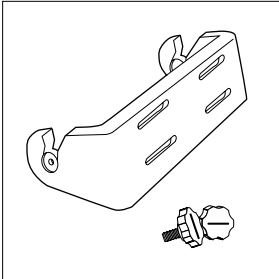

Mounting Bracket
and Knobs

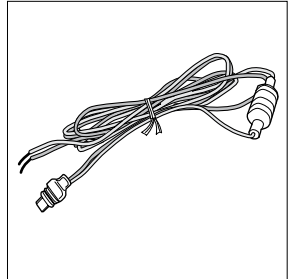

DC Cord

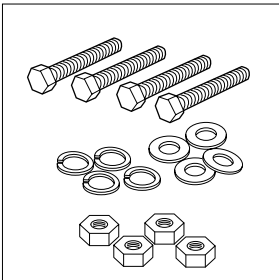

Mounting Hardware

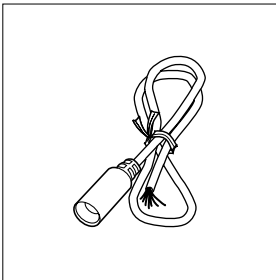

Accessory Cable

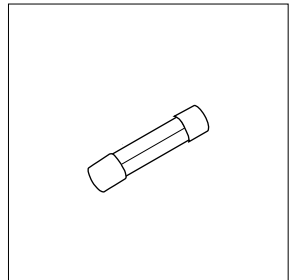

Spare Fuse
250V 6A

Controls and Indicators

Front panel/Microphone

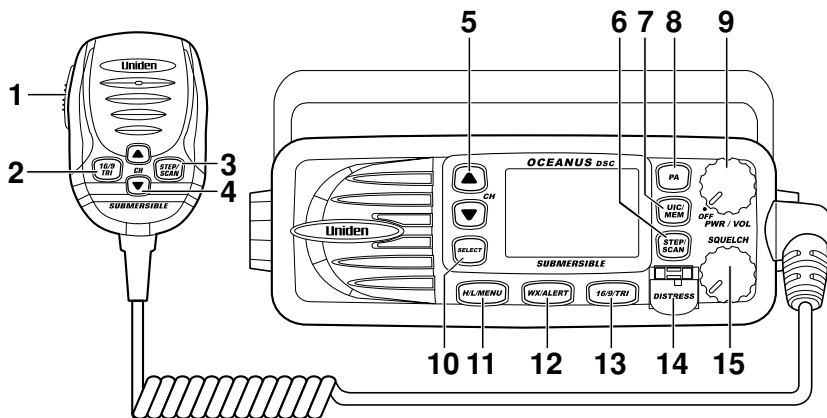

1. **PTT Switch** - Press to transmit and release to receive.
- 2.13. **16/9/TRI** - Press this key instantly change to Channel 16, Channel 9 or current channel. Pressing and holding this key for 2 seconds will activate the triple Watch Feature.
- 3.6. **STEP/SCAN** - Press this key to activate the step operation. Every time this key is pushed, the radio will step to the next channel that has placed into Memory. Pressing and holding this key for 2 seconds will activate the channel scan feature.
- 4.5. **CHANNEL/▲/▼** - These keys are used to change the channel number up/down. These buttons are also used to move the cursor in Menu mode.
7. **UIC/MEM** - Press this key to change channel modes from USA to CANADIAN to INTERNATIONAL. Pressing and holding this key for 2 seconds will place the currently selected channel into Memory. Pressing and holding this key for 2 seconds again will delete the channel from scanning memory.
8. **PA** - Press this key to enable the PA (Public Address) feature.
9. **PWR/VOL (On/Off/Volume)** - Turns the unit On or Off and adjusts the speaker volume.
10. **SELECT** - In the Menu mode this is used to select the menu options.
11. **H/L/MENU** - Press this key to change the transmit power to either High or Low. Press and hold this key for 2 seconds to enter the Menu mode.
12. **WX/ALERT** - Press this key to listen to active NOAA Weather channels. Press and hold this key for 2 seconds to place the radio into the Weather Alert mode.
14. **DISTRESS** - Press this key to send a signal of distress in case of emergency.
15. **SQUELCH** - Rotate this knob eliminate background noise when a signal is not being received.

Rear Panel Connectors

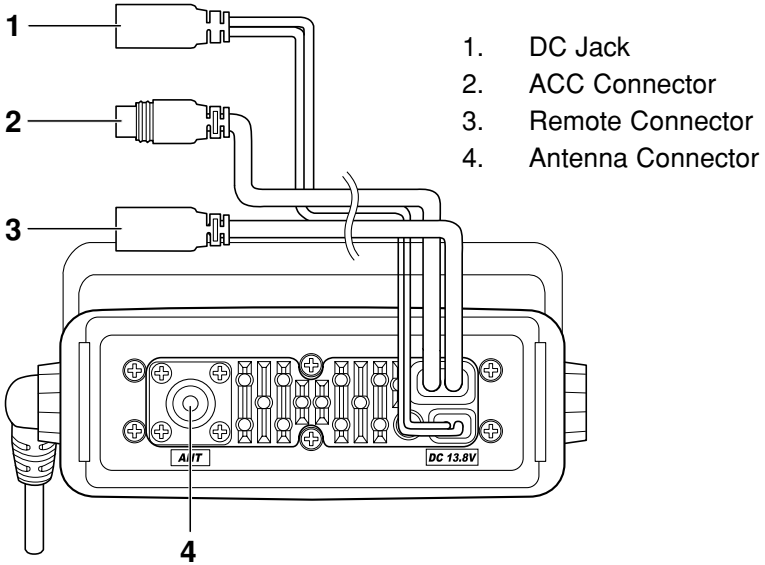

ACC Connector

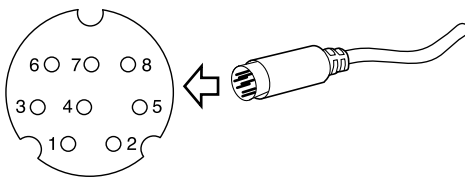

Pin number	Color	Signal
1	ORG	External Speaker (+)
2	RED	DC +13.8V
3	BRN	PA (+)
4	GRN	GPS DATA IN
5		
6	BAR	PA (-) (GND)
7	BLK	External Speaker (-) (GND)
8	BLU	NC

To OCEANUS DSC

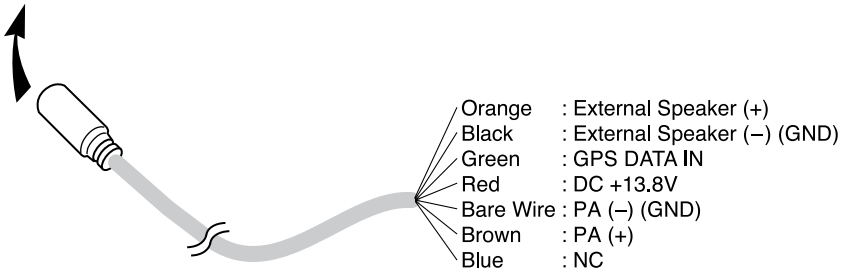

Note: DC13.8V and GND are for GPS ANT.

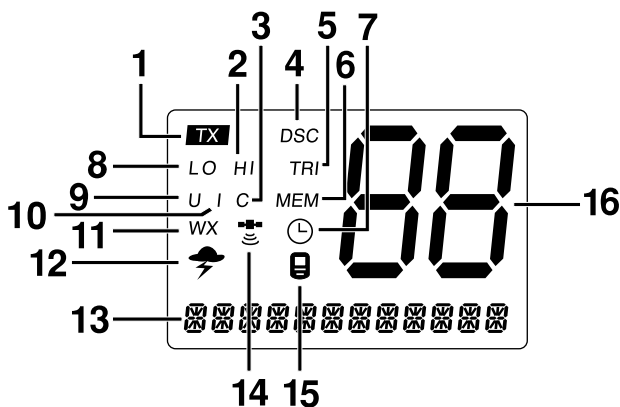

1. **TX** (Transmit) - Indicates transmitting.
2. **HI** (High) - Indicates transmit output is 25 Watts.
3. **C** - Indicates Canada Channel Mode.
4. **DSC** - Indicates the radio is in the DSC mode.
5. **TRI** (Triple Watch) - Indicates Triple Watch Mode is in effect.
6. **MEM** (Memory) - Indicates Memory Scan Mode status for each channel selected.
7. ☹ (**Alarm Icon**) - It appears when the alarm clock is set.
8. **LO** (Low) - Indicates transmit output is 1 Watt.
9. **U** - Indicates US Channel Mode.
10. **I** - Indicates International Channel Mode.
11. **WX** - Indicates Weather Channel Mode has been activated.
12. ⚡ ("**ALT**" **Icon**) - Indicates Weather Alert Mode has been activated.
13. **CH TAG** - This area is used for Channel Tag, Menu, and message of SAME, DSC, GPS, and frequency of weather channel. These messages will continually scroll from right to the left.
14. 📶 (**GPS Icon**) - It appears while GPS module is receiving the data.
15. 📻 (**WHAM Icon**) - It appears when it is connected to the control unit of WHAM.
16. **Channel Display** - Indicates Channel Number in use.

Flow Chart for Menu Operation

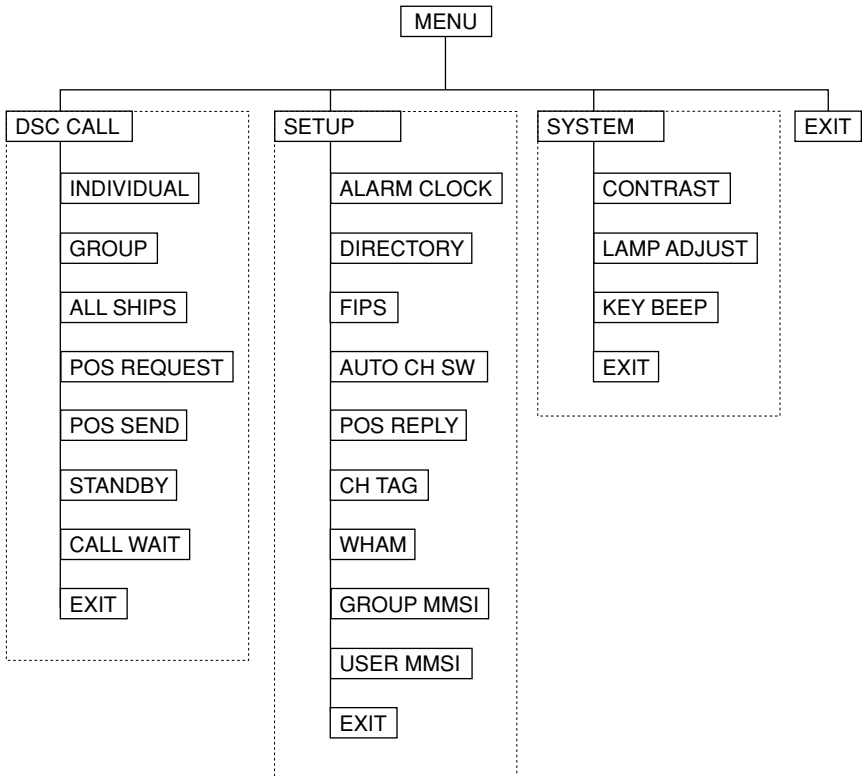

NOTES: "POS SEND" and "ALARM CLOCK" are not displayed in Menu when GPS module is not connected.

When the radio is in one of the following modes: WX Alert mode, Channel 16/9 mode, Scan Mode, or Triple Watch mode, and the user presses the Menu key, all the of these modes are cancelled.

The Menu mode will be cancelled if the radio receives a DSC call or any key is pressed besides the Up arrow, Down arrow, or select keys are pressed.

Installation

Caution: *The **OCEANUS DSC** will only operate with a nominal **12 volt** negative ground battery system.*

It is important to carefully determine the most suitable location for your radio on your vessel. Electrical, mechanical, and environmental considerations must all be taken into account. You should select the optimum relationship among these considerations.

Keep in mind the flexibility designed into the **OCEANUS DSC** so that you can most conveniently use it. Features which should be considered are:

1. The universal mounting bracket may be installed on either the top or bottom of a shelf, on a bulkhead, or for overhead mounting.
2. The REMOTE speaker wires can be used with an auxiliary speaker.
3. All connections are "plug-in" type for easy removal of the radio.
4. Front fire internal speaker allows convenient in-dash mounting using the optional bracket (White - FMB322W, Black - FMB322B).

Choosing a Location

Some important factors to consider in selecting the location for your **OCEANUS DSC**.

1. Select a location that is free from spray and splash.
2. Keep the battery leads as short as possible. Direct connection to the battery is most desirable. If direct connection can not be made with the supplied power lead, any extension should be made with #10 AWG wire. Long extensions should use larger gauge wire.
3. Keep the antenna lead as short as possible. Long antenna leads can cause substantial loss of performance for both receiving and transmitting.
4. Locate your antenna as high as possible and clear from metal objects. The reliable range of coverage is a direct function of the antenna height.
5. Select a location that allows free air flow around the heat sink on the rear of the radio.
6. Select a location well away from the ship's compass. Auxiliary speakers also should be located away from the compass.

Engine Noise Suppression

Interference from the noise generated by the electrical systems of engines is sometimes a problem with radios. The **OCEANUS DSC** has been designed to be essentially impervious to ignition noise and alternator noise. However, in some installations it may be necessary to take measures to further reduce the effect of noise interference. All DC battery wires, antenna lead, and accessory cables should be routed away from the engine and engine compartment, and from power cabling carrying high currents.

In severe cases of noise interference, it may be necessary to install a noise suppression kit. Contact your Uniden Dealer for more information.

Antenna Considerations

A variety of antennas are available from a number of quality suppliers. It is recommended you draw upon the advice of your Uniden dealer in determining a suitable antenna for your vessel and range requirements.

In general, communication range is increased by using a high-gain antenna placed as high as possible above the water line. Antennas should be located away from metal objects. Antennas should not have excessively long coaxial feed cables.

Antenna Selection and Installation

OCEANUS DSC has been designed to accommodate all of the popular marine VHF antennas. However, the selection and the installation of the antenna is the responsibility of the user or installer.

The FCC has determined that excessive radiation poses a health risk to people near radio transmitting antennas. Therefore, the antenna used with this radio should be installed using the following guidelines to insure a suitable distance between the antenna and persons close by.

Small whip antennas (3 dB) or smaller should be installed keeping at least three feet separation distance between the radiating element and people.

Larger antennas (6 dB or 9 dB) should be installed keeping at least a six foot separation distance.

No person should touch the antenna or come into the separation distance when the radio is transmitting.

Installing the OCEANUS DSC

After you have carefully considered the various factors affecting your choice of location, position the radio (with the bracket, microphone, power cord, antenna and any auxiliary cables installed) into the selected location to assure there is no interference with the surrounding items. Mark the location of the mounting bracket. Remove the bracket from the radio and use it as a template to mark the holes to be drilled for the mounting hardware. Drill the holes and mount the bracket with hardware compatible with the material of the mounting surface.

Note: *This HEXAGON HEAD BOLT is only for mounting the bracket with hardware. Do not use it for installing the radio in the mounting bracket.*

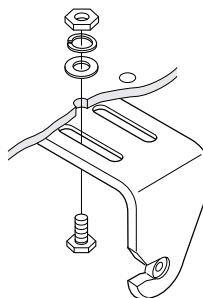

Connect the red wire of the supplied power cord to the positive (+) battery supply. Connect the black wire of the power cord to the negative (-) battery supply. The power cord is equipped with a fuse to protect the radio. Use only a six (6) ampere fast blow fuse for replacement. Connect the power cord to the keyed connector on the power "pigtail".

Connect the antenna and all other auxiliary cables and accessories. Install the radio in the mounting bracket and connect all cables and accessories to the appropriate jacks and connectors.

Note: *Do not use any other mounting knobs than the ones enclosed. Do not insert the knobs without attaching the bracket.*

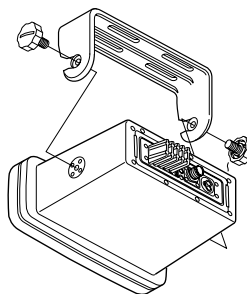

Operation

POWER On/Off

Turn the unit On by rotating the **PWR/VOL** control clockwise.

Adjust the volume to a comfortable level.

When you turn the unit On, you will hear a beep, and the greeting message below appears on the LCD for 3 seconds.

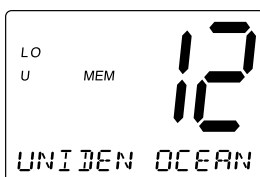
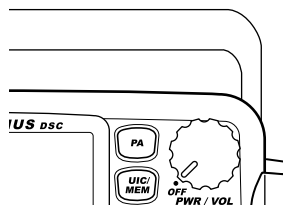

Note: When you turn On the radio for the first time after purchase, the channel 16 will appear on the LCD.

Last Channel Memory

The **OCEANUS DSC** memorizes the last channel selected before you turn Off the radio. For example, if you turn Off the radio on CH 12, it will be on that channel when turned back On.

Note: In order for the last channel to be memorized, you must have the radio on that channel for 3 seconds.

SQUELCH

Turn **SQUELCH** fully clockwise. This raises the “Squelch Gate” so high that only very strong signals can get through.

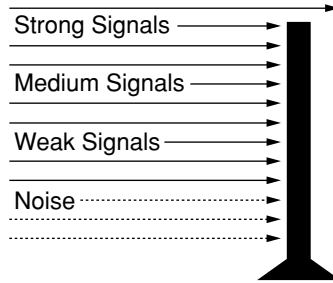
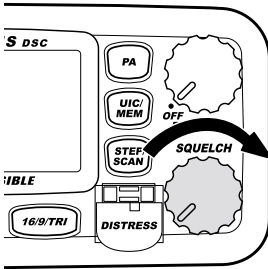

Turn **SQUELCH** fully counterclockwise until you hear a hiss. This lowers the “Squelch Gate” so that everything gets through - noise, weak signals, and strong signals.

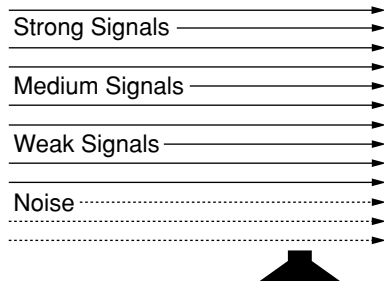
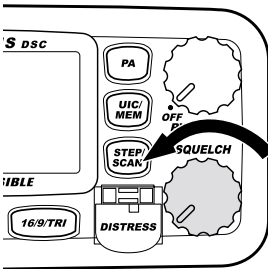

Turn **SQUELCH** back clockwise until the hiss stops. Now the “Squelch Gate” allows only strong signals through.

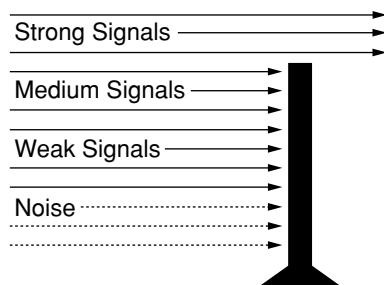
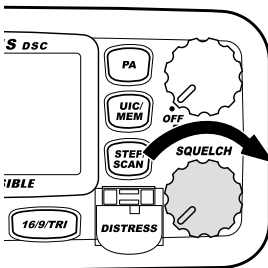

COAST GUARD CHANNEL 16/CHANNEL 9 COMMUNICATIONS

To access Coast Guard Channel 16 or Channel 9 communications, press **16/9/TRI**. You can access Coast Guard 16 CH instantly while tuned to another channel. Press **16/9/TRI** again for Channel 9 Calling communications. Press **16/9/TRI** a third time to return to the channel selected prior to accessing Coast Guard Channel 16/Channel 9 communications.

The display will indicate the selected channel.

To cancel Coast Guard Channel 16/Channel 9 communications:

- Press **16/9/TRI** until the previous channel setting appears.
- or--
- Press **WX/ALERT, CH ▲, ▼** or **STEP/SCAN**.

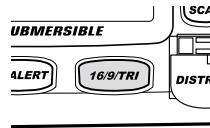

TRIPLE WATCH

Triple Watch monitors Channel 16, Channel 9, and the current Marine Channel or Weather Channel.

To activate Triple Watch, press and hold **16/9/TRI** for 2 seconds. **TRI** appears on the LCD, indicating Triple Watch mode is in effect. If a signal is received on either Channel 16 or Channel 9, the radio remains on that channel until the signal ends.

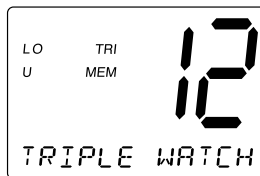

Press and hold **16/9/TRI** for 2 seconds to cancel the Triple Watch mode.

Note: While in Triple Watch mode, you can change the currently selected channel using **CH ▲** and **▼**. A momentary press of the **16/9/TRI** button interrupts Triple Watch mode and remains on channel 16, or on channel 9 if you press **16/9/TRI** once more. To return to the Triple Watch mode, simply press the button again.

MANUAL TUNING

To manually select a channel, press CH ▲ or ▼. Communication channels are located on channel 01-28 and 60-88. Weather channels are located on channels WX 0-9.

WEATHER CHANNELS

To select Weather Channels 0-9, press **WX/ALERT**. The radio will go to the last selected Weather Channel. Press **CH ▲** or **▼** to select a different Weather Channel.

To exit from Weather Channel:

- Press **WX/ALERT**. The radio returns to the previous Marine channel.

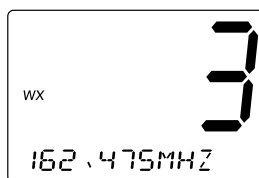

MEM (Entering channel numbers into Memory Scan)

You can enter channels into Memory Scan for instant scanning at any time. When a channel is selected for Memory Scan, **MEM** appears on the LCD display.

To enter a channel into Memory Scan, select the channel you want to store by using CH ▲ and ▼, and then press and hold **UIC/MEM** for 2 seconds. The channel is stored in Memory Scan and **MEM** appears on the LCD display.

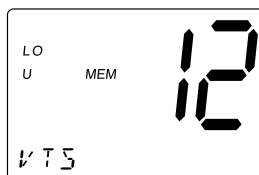

To cancel the channel in Memory, press and hold **UIC/MEM** for 2 seconds. The **MEM** icon disappears.

Note: *The Memory channel can be set independently in 3 regional modes (USA, INT, and CAN). You cannot use this feature in WX mode or for channel 70.*

Triple Watch Scan

To turn Triple Watch Scan On, press and hold **16/9/TRI** for 2 seconds. While the current channel is scanned, Channel 16 and Channel 9 are also scanned every 2 seconds. Then **TRI** appears.

Normal Scan

Normal Scan is performed only when the memory CH is registered.

To turn Normal Scan On, press and hold **16/9/TRI** for 2 seconds in Triple watch Scan mode. Although Memory CH is scanned, Channel 16 and Channel 9 are not.

Triple Watch Alert Scan

To turn Triple Watch Alert Scan On, press and hold **WX/ALERT** for 2 seconds while in Triple Watch Scan mode. While Memory CH is scanned, Channel 16 and Channel 9 are scanned every 2 seconds, and WX CH is scanned every 7 seconds. **TRI** and  icon appear on the LCD.

Alert Scan

To turn Alert Scan On, press and hold **WX/ALERT** for 2 seconds. While Memory CH is scanned, WX CH is scanned every 7 seconds.  icon appears on the LCD.

Weather Alert

The traditional weather feature receives weather broadcast (usually within a 50-mile radius) then sounds an alarm of any emergency code which was transmitted along with the broadcast. This means that people who live outside an affected area are often alerted even when their area is not affected, causing many of them to ignore potentially real emergency/weather warnings that can save lives.

In 1994, the National Oceanic and Atmospheric Administration (NOAA) began broadcasting coded signals called FIPS (Federal Information Processing System) codes along with their standard weather broadcasts from stations in your area. These codes identify an emergency and the specific geographic area (such as a county) affected by the emergency.

The **OCEANUS DSC** was developed with the SAME (Specific Area Message Encoding) technology. This allows your radio to receive, interpret, and display the information about the codes so you can determine if the emergency might affect your area.

Each FIPS code identifies a specific geographic area (defined by the National Weather Service), so your radio sounds an alert only when an emergency/weather emergency is declared in those locations. This helps you more efficiently track the emergency/weather conditions in and around your area.

The Weather Alert mode can be activated to alert you of dangerous weather. When Weather Alert is turned On, and a warning signal is received, an emergency siren will sound at full volume, regardless of the volume setting. When the signal stops, you will hear the active weather channel broadcast at the normal volume.

Note: See *SETUP mode to program up to 10 FIPS codes.*

The ⚡ icon indicates the Weather Alert mode is activated. To activate the Weather Alert mode:

1. Press and hold **WX/ALERT** for 2 seconds when WX ALERT is Off. The radio turns the WX ALERT On and the ⚡ icon appears.

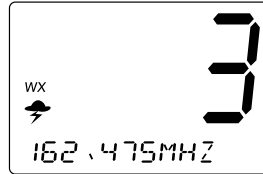

2. If the radio receives a 1050Hz tone, the ⚡ icon will blink every other second and the alert tone will ring. In the area where SAME is broadcasted, the following is displayed.

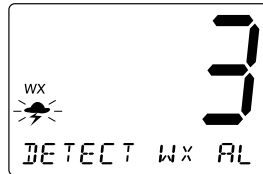

3. When a WX ALERT signal is received, all other functions are canceled and the radio remains on the selected weather channel.

When the radio is in Scan mode, scanning the weather channel every 7 seconds, the SAME signal is not

decoded. To decode the SAME signal, the radio should be on an active weather channel.

In order to stop the alert press any key. If you press any key once more, the alert icon disappears.

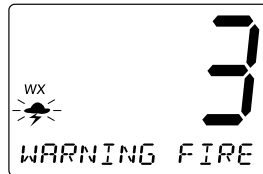

TRANSMITTING

The **OCEANUS DSC** transmits on fifty-four marine frequencies and receives on eighty marine frequencies. Channel 70 of the USA, International, and Canadian frequencies, and channel 15 of the USA frequencies, and WX CH – are for receiving only. The radio transmits on channel 70 when sending DSC information. Your radio will not transmit on these channels. For your reference, a listing of all the available marine channels are located on pages 55 - 57.

SETTING TX OUTPUT

Caution: *It is important to remember to use the LO position in port or for short range communications.*

1. When you turn the radio On for the first time, the unit is automatically set to transmit at 25 watts (HI).

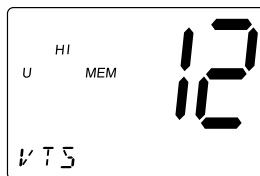

2. Press **H/L/MENU** to change the transmitter output to 1 watt (LO).

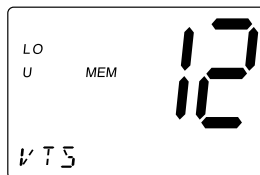

3. Press **H/L/MENU** again to change back to 25 watts (HI).

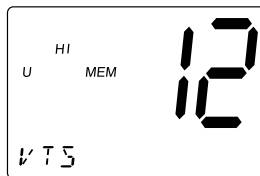

Note: *Each time the **H/L/MENU** is pressed a short tone sounds. CH13 is set as 1 watt (LO) channel. When the channel is set as LO power channel, you can transmit at 25 watts (HI) by pressing and holding **H/L/MENU** during the call. LO power channels are 13 and 67 for USA, and 13, 15, 17, and 20 for CAN.*

DISTRESS

Note: You must set the user MMSI in order to send a Distress call. Please see page 40 to set the MMSI.



This feature will allow you to transmit a Distress call.

1. In order to transmit a Distress call, press and hold **DISTRESS** for 5 seconds.

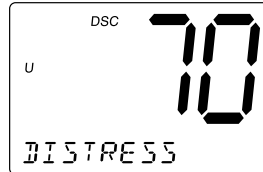

2. The Distress call is transmitted and it waits for about 210 - 270 seconds. This is continued internally. After the Distress call has been sent, the Distress alert will sound every other second, and it also "shadow-watches" for a transmission between CH16 and CH70 until an acknowledgment signal is received from the Coast Guard shore station.

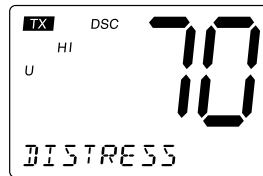

To cancel the Distress call, press **16/9/TRI**.

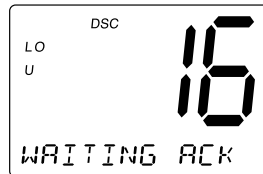

3. When the radio receives a Distress call, the following screen appears. If an acknowledgment is not received, the Distress call is repeated until an acknowledgment is received from the Coast Guard shore station.

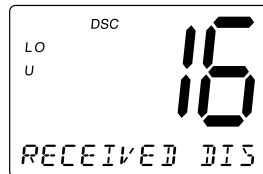

Note: If the radio receives a Distress call, it will be displayed on the LCD display. An emergency alert will sound. The name will be displayed if it is the name registered in the directory. Otherwise, sender's MMSI is displayed. Latitude, longitude, and time information will also be displayed if the GPS module is carried in the vessel that transmitted a DSC Distress call.

MARINE DISTRESS PROCEDURE

Speak slowly – clearly – calmly.

1. Make sure your radio is On.
2. Tune to Channel 16.
3. Press the PTT button on the microphone and say: "MAYDAY – MAYDAY – MAYDAY."
4. Give your ship ID.
5. Say "MAYDAY [your ship name]."
6. Give your location: (what navigational aids or landmarks are near).
7. State the nature of your distress.
8. Give the number of persons aboard and the conditions of any injured.
9. Estimate present seaworthiness of your vessel.
10. Give a brief description of your vessel (meters, type, color, hull).
11. Say: "I will be listening on Channel 16".
12. End message by saying "THIS IS [your ship name or call sign] OVER."
13. Release the PTT button and listen. Someone should answer. If not, repeat call, beginning at Item 3 above.

Menu Operation

1. DIGITAL SELECTIVE CALLING (DSC)

Digital Selective Calling is a process of establishing a radio call, it has been chosen by the International Maritime Organization (IMO) as an international standard for establishing VHF, MF and HF radio calls. Digital Selective Calling has also been selected as part of the Global Maritime Distress and Safety System (GMDSS).

This service will let you instantly send a Distress call with GPS position (when optional GPS receiver is connected to the **OCEANUS DSC**) to the US Coast Guard and other vessels within range of the transmission. DSC will also let you initiate or receive distress, urgency, safety, position information and routine calls to or from another vessel outfitted with a DSC transceiver.

See the directory section for instructions on how to setup the directory of names.

- Note:**
- *Position SEND and ALARM CLOCK will not be displayed if GPS is not connected.*
 - *Refer to page 7 for the flow chart of Menu Operation.*

1. Press and hold **H/L/MENU** for 2 seconds to enter Menu Operation.

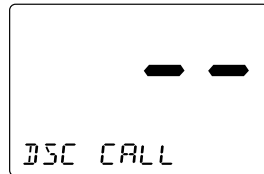

2. Press **SELECT** to enter DSC CALL.

DSC CALL has 7 options as follows.

To exit, select EXIT.

1-A. INDIVIDUAL

1. Press **SELECT** at DSC CALL.

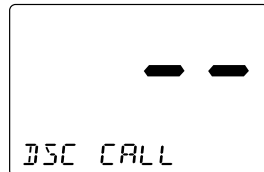

2. **INDIVIDUAL** appears.
Press **SELECT**.

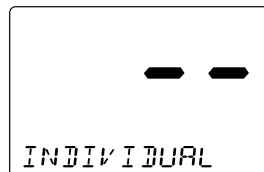

3. Select the individual you want to contact using **CH ▲** and **▼**. Press **SELECT** to transmit the individual DSC signal.

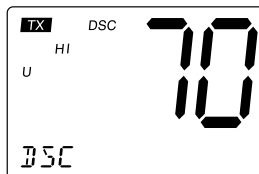

4. **WAITING** appears followed by the individual you have selected, and the radio use 70 CH while transmitting.

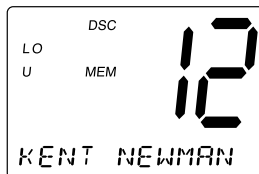

5. When you receive the individual acknowledgment successfully, **WAITING** will change to **COMPLETED**. Both radios tune to the selected channel. You are now ready to transmit on that channel.

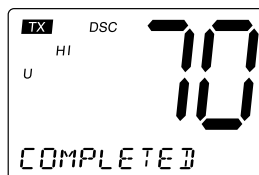

Note: *If there is not any data registered in the directory you cannot proceed to the 2nd step. See the **SETUP** section for directory, setup instructions.
Select an open (unused) working channel first, then make the call. After the acknowledgment, both radios tune to the previously selected channel.*

1-B. GROUP

1. Press **SELECT** at **DSC CALL** (To enter **DSC CALL**, see page 21). **INDIVIDUAL** appears.

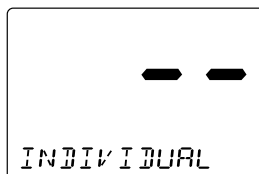

2. Press **CH ▼** once to select **GROUP**.

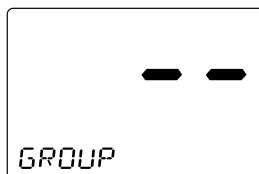

3. Press **SELECT**. The MMSI code appears, and you can now call the group members. Press **SELECT** to call. When you finish calling, the radio returns to the channel display screen.

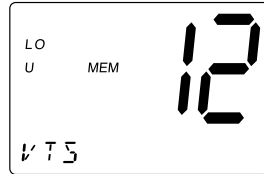
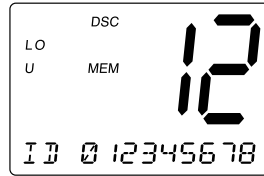

1-C. ALL SHIPS

1. Press **SELECT** at DSC CALL (To enter DSC CALL, see page 21). INDIVIDUAL appears.
2. Press **CH ▼** twice to select ALL SHIPS.
3. Press **SELECT**. URGENCY appears.

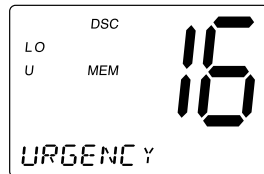
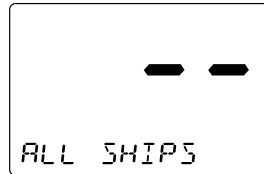
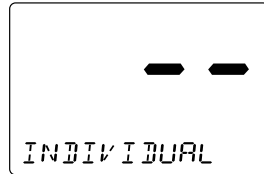

- Select the category of your call using **CH ▲** and **▼** (URGENCY, SAFETY, ROUTINE).

Note: ROUTINE calls tune to the previously selected channel.

- Press **SELECT** to transmit the ALL SHIPS DSC signal.
When sending either an URGENCY or SAFETY message, all radios will automatically move to channel 70 until all of the data is received.

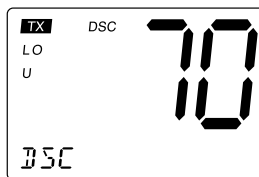

- After selecting URGENCY or SAFETY ALL SHIPS call is transmitted, the radio will switch to Channel 16. You should wait a few minutes before transmitting the ALL SHIPS call information.



1-D. POSITION REQUEST

This radio has the ability to request the position of an individual vessel that is registered in the DIRECTORY.

- Press **SELECT** at DSC CALL (To enter DSC CALL, see page 21). INDIVIDUAL appears.
- Press **CH ▼** three times to select POS REQUEST.

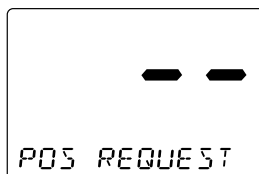
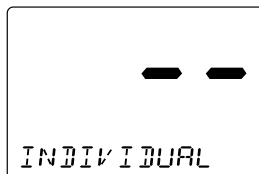

3. Press **SELECT**. The individual directory appears.

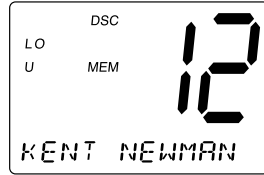

4. Select the name to request the individual's position using **CH ▲** and **▼**.

5. Press **SELECT** to transmit the position request call.
POS WAITING appears followed by the individual, and the radio use 70 CH while transmitting.

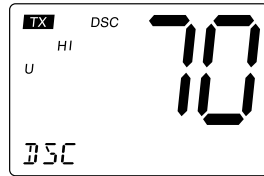

6. When the called vessel sends the position information, time and position appears followed by the individual. You can see the time and the position.



Note: *The requested radio must have the ability to transmit the position information (such as having a **OCEANUS DSC** radio).*

1-E. POSITION SEND

This radio has the ability to send the position of your vessel to another vessel using a VHF marine radio equipped with DSC.

Note: *Position send is only available when it is connected to the GPS.*

1. Press **SELECT** at DSC CALL (To enter DSC CALL, see page 21).
INDIVIDUAL appears.

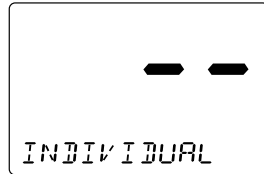

2. Press **CH** ▼ four times to select POS SEND.

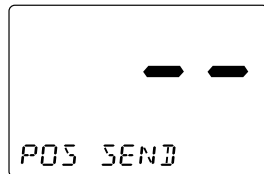

3. Press **SELECT**. The individual directory appears.

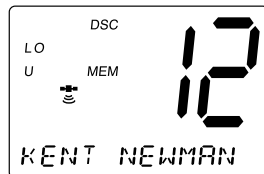

4. Press **SELECT** to send your position information.

5. The following screen appears.

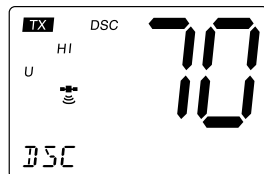

1-F. STANDBY

The DSC STANDBY function allows the **OCEANUS DSC** to answer DSC calls with the UNATTENDED message and record the calls for response at another time. When you set the radio to DSC STANDBY mode, voice traffic may still be active on any chosen channel.

1. Press **SELECT** at DSC CALL (To enter DSC CALL, see page 21). INDIVIDUAL appears.

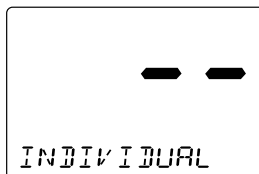

2. Press **CH ▼** five times to select STANDBY. Then press **SELECT**.

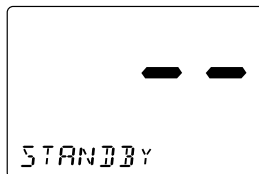

3. When an individual DSC call is received, the radio will respond with the UNATTENDED message when an operator cannot answer the call. The DSC call will be recorded into the radio's Call Waiting directory.

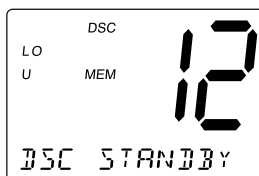

Note: If you press a key on the radio or the PTT, this feature will be canceled.

1-G. CALL WAIT

The DSC Call Waiting directory records 10 received distress calls, and records 20 individual calls that are received and not answered within 5 minutes or while the radio is set to DSC Standby. Calls will be recorded while you are busy with other communications as long as the transmitter is not keyed at the time of the call. If the call is answered within 5 minutes the call will not be recorded. When a call is recorded, a message appears.

1. Press **SELECT** at DSC CALL (To enter DSC CALL, see page 21). INDIVIDUAL appears.

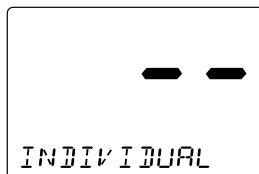

2. Press **CH** ▼ repeatedly to select CALL WAIT.

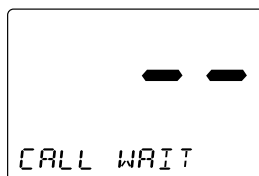

3. Press **SELECT**. The CALL WAIT directory appears.

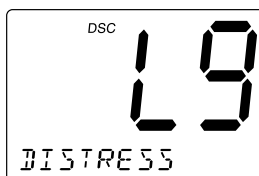

4. Select the options you want to view using **CH** ▲ and ▼.

Note: *If a call has not been logged, the radio will beep and you will not be able to proceed to the next step.*

5. Press **SELECT**.

6. If a DISTRESS call is received in Call Wait, the following display appears.

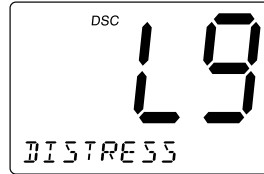

If an INDIVIDUAL call is received in Call Wait, the following display appears. At this point, you can call back any of the radios in the log.

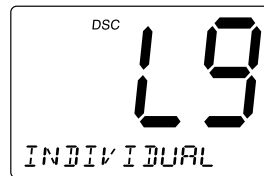

7. Press **SELECT**. Received data appears.

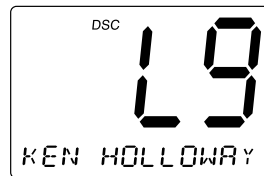

8. Using CH ▲ and ▼ allows you to look through all of the data. If you press **SELECT**, the radio starts transmitting.

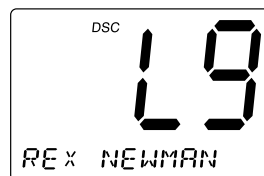

Geographical Call

This function can receive the electric wave transmitted towards the ship that is present in the domain specified from the call side.

Note: *The radio receives geographical calls only, and sending geographical calls is not available. It indicates the time when the geographical call is received.*

2. SETUP

1. Press and hold **H/L/MENU** for 2 seconds to enter Menu Operation.
2. Press **CH ▼** once to display **SETUP**, and press **SELECT**.

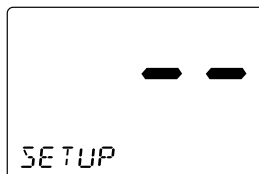

SETUP has 9 options as follows. To exit, select **EXIT**.

2-A. ALARM CLOCK

This feature is only available when the GPS is connected to the NMEA0183 Accessory Wires. If it is connected to the GPS, the alarms are set based on the satellite. You need to set the time previously to setting the alarm.

2-A-1. ALARM SET

This feature allows you to set the alarm.

1. Press **SELECT** at **SETUP**. **ALARM CLOCK** appears.
2. Press **SELECT**.
3. Press **CH ▲** or **▼** to select **On**. Then, press and hold **SELECT**.
4. Select the hour using **CH ▲** and **▼**, then press **SELECT**.
5. Select the minute using **CH ▲** and **▼**, then press **SELECT**.

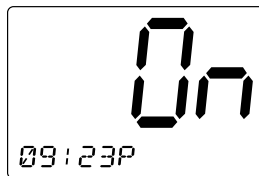
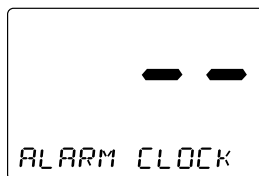

6. Select AM or PM using **CH ▲** or **▼**, then press **SELECT**.
7. A confirmation screen appears.

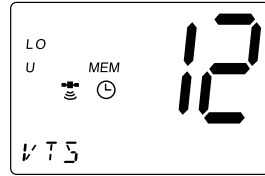

2-A-2. ALARM ON

This feature allows you to turn the alarm ON.

1. Press **SELECT** at **SETUP** (To enter **SETUP**, see page 30).
2. **ALARM CLOCK** appears. Then, press **SELECT**.
3. Press **SELECT** again.
4. Select **On**. Using **CH ▲** or **▼**, and press **SELECT**. The radio returns to the channel display screen and the **⌚** icon appears.
5. When the radio reaches the set time the alarm sounds and the **⌚** icon blinks.

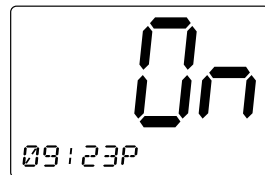
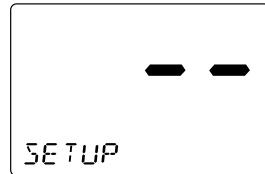

Note: *The alarm sounds when the set time is reached, you can turn the alarm Off by pressing any key. Alarm mode will turn Off automatically once the alarm sounds.*

2-A-3. ALARM OFF

This feature allows you to turn the alarm OFF.

1. Press **SELECT** at **SETUP** (To enter **SETUP**, see page 30).
2. **ALARM CLOCK** appears.
3. Press **SELECT**.
4. Select **OF** using **CH ▲** or **▼**, then press **SELECT**.
5. Press **SELECT**. The radio returns to the channel display screen and the ⌚ icon disappears.

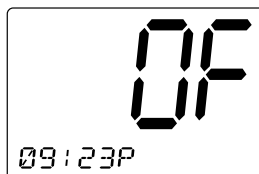
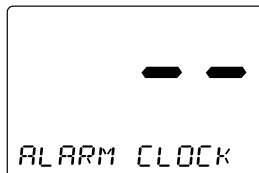

2-B. DIRECTORY

This function will allow you to send an individual call, etc. The Directory function memorizes the name and MMSI number of 20 other vessels. The following screen will allow you to setup an alphanumeric identity as well as the corresponding MMSI number.

1. Press **SELECT** at **SETUP** (To enter **SETUP**, see page 30).



2. Display **DIRECTORY** using **CH ▲** and **▼**.



3. Press **SELECT**. The **DIRECTORY** menu appears. Use **CH ▲** and **▼** to select the menu.

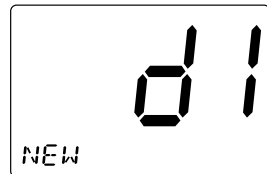

2-B-1. NEW

This function will allow you to enter new information into the directory.

1. Press **SELECT** at **NEW**. The registering screen appears.

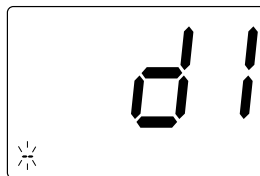

2. You can now enter the person's name. Press **CH ▲** repeatedly to choose the alphabet. The character will be entered when **SELECT** is pressed, and the blinking digit moves to the right.

3. After you enter the person's name, you can enter their MMSI number. Press **CH ▲** to increase the number, **CH ▼** to decrease. The number will be entered when **SELECT** is pressed, and the blinking digit will move to the right.

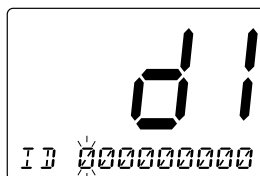

4. When you finish entering the last digit, the radio returns to **NEW** screen.

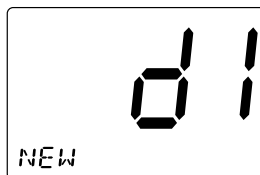

2-B-2. EDIT

If you want to edit the DIRECTORY

1. Press **SELECT** at the individual you want to edit.

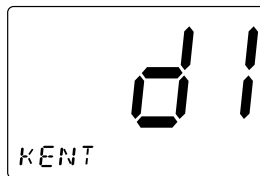

2. **EDIT** appears, then press **SELECT**.

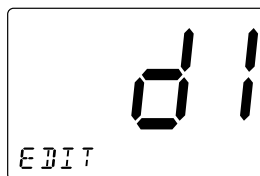

3. You can now edit the person's name. Press **CH ▲** repeatedly, and press **SELECT** to choose the alphabet. See the step 2 of 3-E-1 for detail.
4. After you edit the person's name, you can edit the MMSI. Press **CH ▲** to increase the number, **CH ▼** to decrease. The number will be entered when **SELECT** is pressed, and the blinking digit moves to the right.
5. After the directory data is edited, the individual appears.

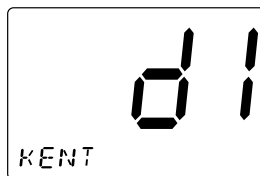

2-B-3. DELETE

If you want to delete the directory

1. Press **SELECT** at the individual you want to delete.

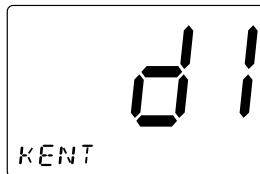

2. Press **CH ▼** once. **DELETE** appears, then press **SELECT**.

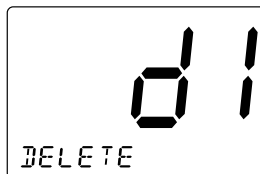

3. The radio displays the next individual. If no more code remains, **EXIT** appears.

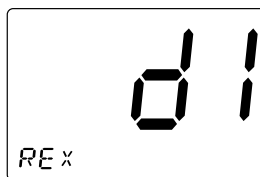

2-C. FIPS

The 6-digit Federal Information Processing System (FIPS) code established by the National Weather Service (NWS) identifies geographic areas in the United States. Programming FIPS codes are necessary to receive SAME alerts about weather occurring in a particular area. To obtain the FIPS code for a particular area contact the NWS toll free at 1-888-NWR-SAME (1-888-697-7263).

Or visit their website: <http://www.nws.noaa.gov/nwr/indexnw.htm>.

A list of event codes are located on page 58.

To set FIPS code

1. Press **SELECT** at **SETUP** (To enter **SETUP**, see page 30).

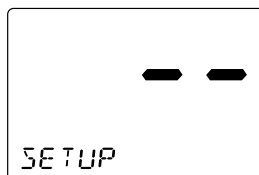

2. Display **FIPS** using **CH ▲** and **▼**.

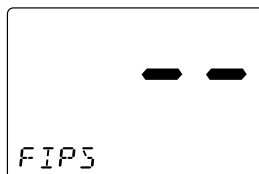

3. Press **SELECT**. The FIPS menu appears. Use **CH ▲** and **▼** to select the menu.

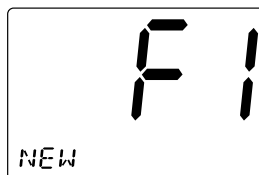

2-C-1. NEW

If you want to register a new FIPS code

1. Press **SELECT** at **NEW**. The registering screen appears.

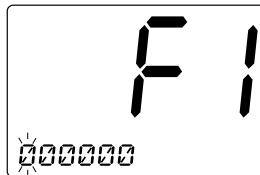

2. You can now enter the new FIPS code. Press **CH ▲** to increase the number, **CH ▼** to decrease. The number will be entered when **SELECT** is pressed, and the blinking digit moves to the right. When you finish entering the last digit, the radio returns to **NEW** screen.

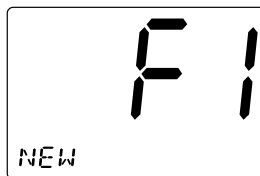

2-C-2. EDIT

If you want to edit the FIPS code

1. Press **SELECT** at the code that you want to edit.

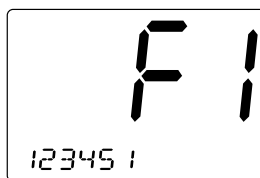

2. **EDIT** appears, then press **SELECT**.

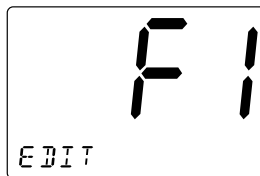

3. You can now edit the FIPS code. Press **CH ▲** increase the number, **CH ▼** to decrease. The number will be entered when **SELECT** is pressed, and the blinking digit moves to the right.

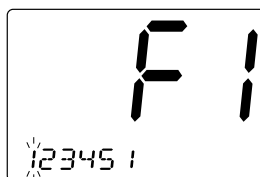

4. When you finished editing the last digit, the confirmation screen appears.

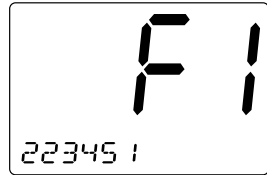

2-C-3. DELETE If you want to delete a directory entry

1. Press **SELECT** at the code that you want to delete.

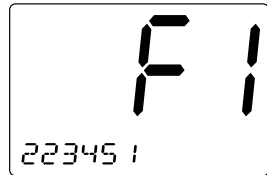

2. Press **CH ▼** once. **DELETE** appears, then press **SELECT**.

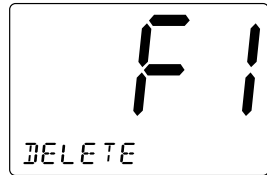

3. The radio displays the next code. If no more code remains, **EXIT** appears.

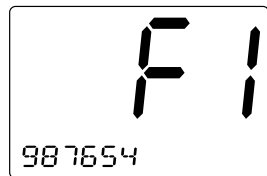

2-D. AUTO CHANNEL SWITCH

This feature is to allow you to disable the automatic channel change that happens when receiving a DSC call. This feature is useful when engaged in bridge – to – bridge or other safety related calls. When you have completed these calls, all of the incoming DSC calls received are available in the call log.

1. Press **SELECT** at SETUP (To enter SETUP, see page 30).

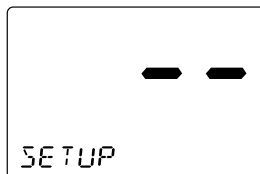

2. Display AUTO CH SW using **CH ▲** and **▼**.

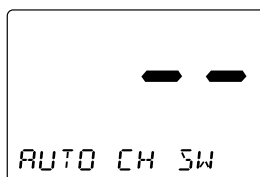

3. Press **SELECT** to enter the setting mode.

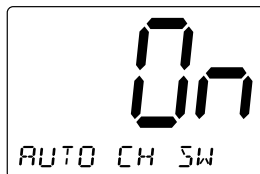

4. If you want to change this mode to off, press **CH ▼** once. (Default is set as ON.)

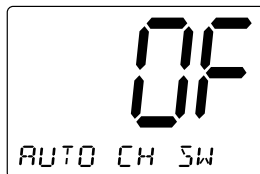

5. Press **SELECT**. The radio returns to the AUTO CH SW screen.

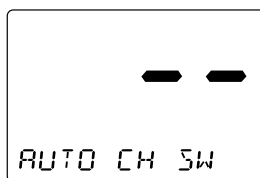

2-E. POSITION REPLY

When the calling radio has requested the position information of your radio, you can decide to transmit an acknowledgment automatically or on a call by call basis.

1. Press **SELECT** at **SETUP** (To enter **SETUP**, see page 30).



2. Display **POS REPLY** using **CH ▲** and **▼**.

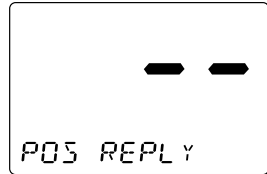

3. Press **SELECT** to enter the setting mode.



4. Press **CH ▲** or **▼** to make your selection.

Example: On

When the radio receives a position request, the following screen appears.

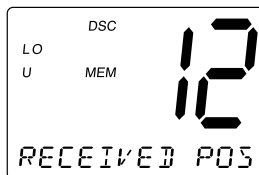

Example: OF

When the radio receives a position request, the following screen appears. You can select whether reply the request or not. If you wants to reply press **SELECT**.

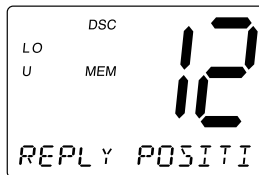

5. Press **SELECT**. The radio returns to the POS REPLY screen.



2-F. CH TAG

This feature allows you to name each marine channel.

1. Press **SELECT** at **SETUP** (To enter **SETUP**, see page 30).



2. Display **CH TAG** using **CH ▲** and **▼**.

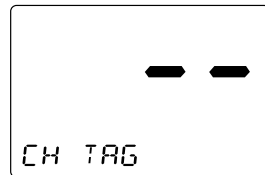

3. Press **SELECT**. The channels and its names appear.

4. Press **CH ▲** and **▼** repeatedly to select the channel that you would like to **EDIT** or **DELETE**.

Note: *The **OCEANUS DSC** radio comes pre-programmed with default channel names.*

2-F-1. EDIT

If you want to edit the channel name

1. Press **SELECT** at the individual channel you want to edit.



2. You can edit the name. Press **CH ▲** or **▼** to select the alphabet, numeric, or symbols. The character will be entered when **SELECT** is pressed, and the blinking digit moves to the right.

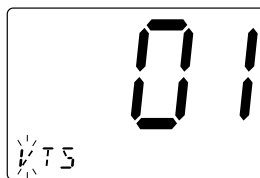

3. Press and hold **SELECT** when you enter the last digit.

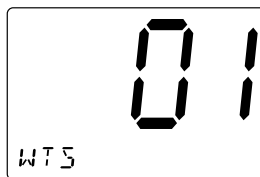

2-G. WHAM (Wireless Handheld Access Microphone)

This feature, from the setup menu, will allow you to connect the **WHAM**.

Note: When you use the **WHAM** in addition to the **OCEANUS DSC** wired mic, please set the **BASE ID** for the **WHAM** the same as your **OCEANUS DSC**. (Please refer to the Owner's Manual for the **WHAM**).

1. Press **SELECT** at **SETUP** (To enter **SETUP**, see page 30).

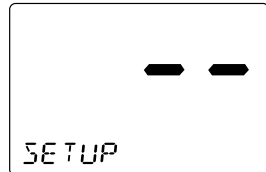

2. Display **WHAM** using **CH ▲** and **▼**.

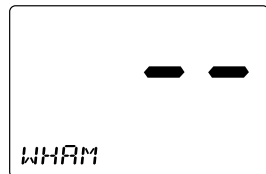

3. Press **SELECT**. **BASE ID** appears.

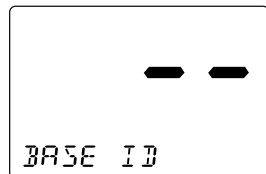

2-G-1. BASE ID

This number consist of 4 digits that you decide yourself. This feature allows you to set the Base ID. To use the **WHAM**, you must set the same Base ID for your **OCEANUS DSC** and **WHAM**, which enables your **OCEANUS DSC** and **WHAM** to communicate with one another.

1. Press **SELECT** at **BASE ID**, the following screen appears.

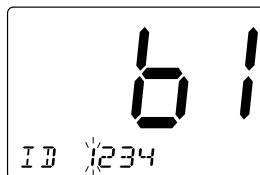

2. Press **CH ▲** to increase the number, **CH ▼** to decrease. The number will be entered when **SELECT** is pressed, and the blinking digit moves to the right. (You can select the number 0000 to 9999.)

3. Press and hold **SELECT** to enter the last digit. The radio returns to the **BASE ID** screen.

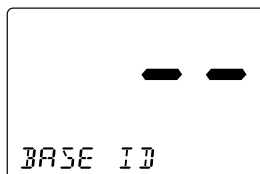

2-G-2. LINK CH

This feature allows you to change the channel between your **OCEANUS DSC** and the **WHAM** if you encounter interference.

1. Press **CH ▼** once at **BASE ID**.
LINK CH appears.

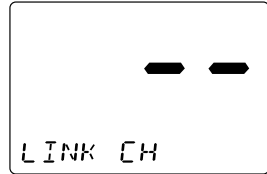

2. Press **SELECT** to enter the editing mode.

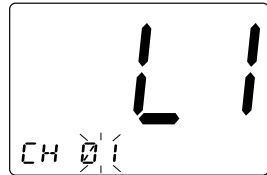

3. Press **CH ▲** to increase the number, **CH ▼** to decrease. The number will be entered when **SELECT** is pressed.

4. The radio returns to the **LINK CH** screen.

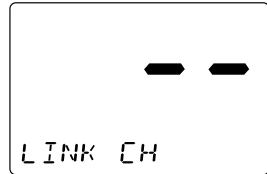

Note: You can select the channel 01-20.

2-H. GROUP MMSI

1. Press **SELECT** at **SETUP** (To enter **SETUP**, see page 30).

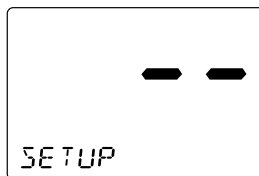

2. Display **GROUP MMSI** using **CH ▲** and **▼**.

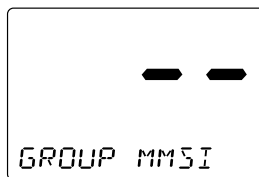

3. Press **SELECT**. The group MMSI ID screen appears.

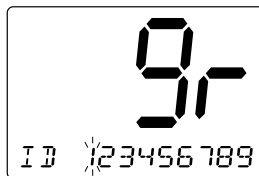

4. You can now enter the **GROUP MMSI** code. Press **CH ▲** to increase the number, **CH ▼** to decrease. The number will be entered when **SELECT** is pressed, and the blinking digit moves to the right.

5. After the final digit is entered, a confirmation screen appears. Press **SELECT** and the radio returns to the following screen.

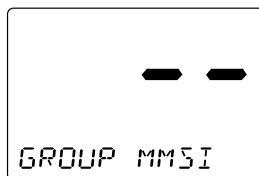

2-I. USER MMSI

Federal MMSI's are issued by the National Telecommunications and Information Administration. Non-Federal MMSI's are issued by the Federal Communications Commission (FCC). You will need to obtain a nine digit MMSI number and program it into the **OCEANUS DSC**. The information obtained from the application is useful to the U.S. Coast Guard to help in search and rescue operations. To obtain an MMSI number, contact your authorized Uniden dealer or visit one of the following websites: <http://wireless.fcc.gov/marine/fctsht14.html>, www.boatus.com/mmsi/, or www.maritel.com

This portion of the SETUP menu will allow you to program an MMSI, (Maritime Mobile Service Identity) for sending and receiving DSC calls.

To set USER MMSI code

1. Press **SELECT** knob at SETUP.

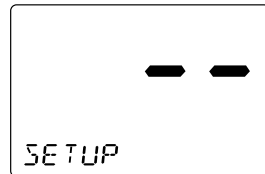

2. Press **CH ▼** eight times to select USER MMSI.

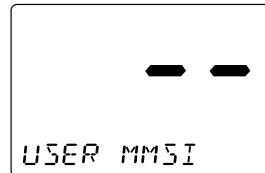

3. Press **SELECT**. The user MMSI ID screen appears.

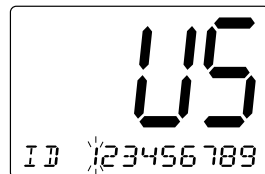

4. You can now enter the USER MMSI code. Press **CH ▲** to increase the number, **CH ▼** to decrease. The number will be entered when **SELECT** is pressed, and the blinking moves to the right.
5. After the final digit is entered, press and hold **SELECT**. The radio returns to USER MMSI screen.

Note: *You can only program your radio twice with an MMSI number. After that, send your radio to Uniden for factory service.*

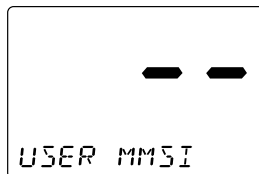

3. SYSTEM

1. Press and hold **H/L/MENU** for 2 seconds to enter Menu Operation.
2. Press **CH ▼** twice to display **SYSTEM**, and press **SELECT**.

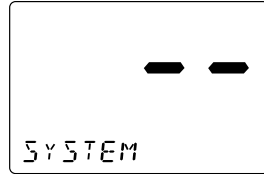

SYSTEM has 3 options as follows. To exit, select **EXIT**.

3-A. CONTRAST

1. Press **SELECT** at **SYSTEM**. **CONTRAST** appears.
2. Press **SELECT** to enter the setting mode. (Default is set at 6).
3. Press **CH ▲** and **▼** to increase or decrease the contrast level. (Default is set to 6).
4. When you find the most favorable brightness, press **SELECT**. The radio returns to the **CONTRAST** screen. If you want to exit the setting screen without changing the contrast, press **H/L/MENU**.

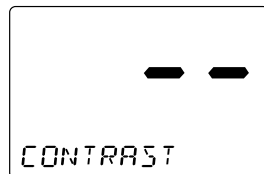

Note: There are 8 contrast levels (0 - 7).

3-B. LAMP ADJUST

1. Press **SELECT** at SYSTEM.

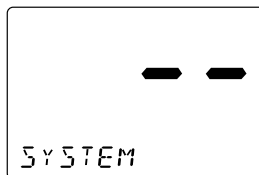

2. Press **CH** ▼ once to select LAMP ADJUST.

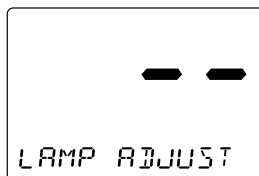

3. Press **SELECT** to enter the setting mode.



4. Press **CH** ▲ and ▼ to select the backlight brightness level. (Default is set to 2).

5. When you find the most favorable brightness, press the **SELECT**. The radio returns to the LAMP ADJUST screen.

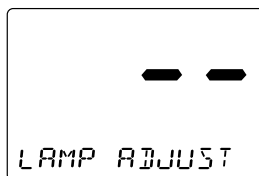

Note: The backlight settings are off, Level 1 Dim, Level 2 medium, and Level 3 bright.

3-C. KEY BEEP

1. Press **SELECT** at SYSTEM.

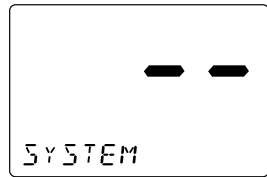

2. Press **CH** ▼ twice to select KEY BEEP.

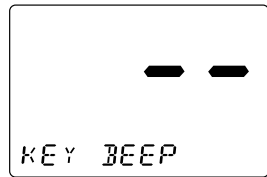

3. Press **SELECT** to enter the setting mode.



4. Press **CH** ▲ and ▼ to select ON or OFF.

5. Press **SELECT**. The radio returns to the KEY BEEP screen.

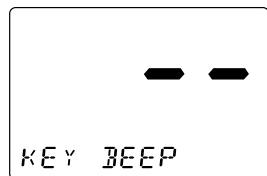

NMEA Technical Setup

OCEANUS NMEA0183 GPS Input Connection Specification

This section is useful when attaching an external GPS to the **OCEANUS DSC** radio. Many GPS units have a setup menu to be able to configure the NMEA0183 serial data output. This output can be used to supply information to other devices on the vessel, such as the **POLARIS DSC** VHF radio, auto pilots, chart plotters, etc.

To setup the GPS to be used with the **OCEANUS DSC** radio, the following items need to be considered for proper operation:

1. Baud Rate – Set the Baud rate to 4800.
2. Data Bits – Set the Data Bits to 8.
3. Parity – Set the Parity to None.
4. Stop Bits – Set the Stop Bits to 1.
5. GPRMC Command – This command is used by the **OCEANUS DSC** and includes the UTC Time, Latitude, Longitude, Speed, Direction, and Date information.

The data amplitude : Over 3.0V

Drive capability : Over 10mA

Optional Accessories

- Flush mounting bracket for “in dash” installation.
(White = FMB322W, Black = FMB322B)

Contact your Uniden Dealer for information.

VHF FM Marine Radio Telephone Channel and Functions (USA Channels)

CHANNEL DESIG	FREQUENCY (MHz)		TYPE OF TRAFFIC	SHIP TO SHIP	SHIP TO SHORE	CH TAG
	TRANSMIT	RECEIVE				
WX0	—	163.275	NOAA Weather	RX Only	RX Only	
WX1	—	162.550	NOAA Weather	RX Only	RX Only	
WX2	—	162.400	NOAA Weather	RX Only	RX Only	
WX3	—	162.475	NOAA Weather	RX Only	RX Only	
WX4	—	162.425	NOAA Weather	RX Only	RX Only	
WX5	—	162.450	NOAA Weather	RX Only	RX Only	
WX6	—	162.500	NOAA Weather	RX Only	RX Only	
WX7	—	162.525	NOAA Weather	RX Only	RX Only	
WX8	—	161.650	Can. Weather	RX Only	RX Only	
WX9	—	161.775	Can. Weather	RX Only	RX Only	
01	156.050	156.050	VTS	Yes	Yes	VTS
02						
03	156.150	156.150	Port Ops	Yes	Yes	
04						
05	156.250	156.250	VTS	Yes	Yes	VTS
06	156.300	156.300	Safety	Yes	No	SAFETY
07	156.350	156.350	Com'l	Yes	Yes	COMMERCIAL
08	156.400	156.400	Com'l	Yes	No	COMMERCIAL
09	156.450	156.450	Com'l & Non Com'l	Yes	Yes	CALLING
10	156.500	156.500	Com'l	Yes	Yes	COMMERCIAL
11	156.550	156.550	Com'l	Yes	Yes	VTS
12	156.600	156.600	Port Ops	Yes	Yes	VTS
13	156.650	156.650	Navigational, TX 1W only	Yes	Yes	BRG/BRG
14	156.700	156.700	Port Ops	Yes	Yes	VTS
15	—	156.750	Environmental	RX Only	RX Only	COMMERCIAL
16	156.800	156.800	Safety Calling	Yes	Yes	DISTRESS
17	156.850	156.850	State Control	Yes	Yes	SAR
18	156.900	156.900	Com'l	Yes	Yes	COMMERCIAL
19	156.950	156.950	Com'l	Yes	Yes	COMMERCIAL
20	157.000	157.000	Port Ops, RX Duplex	Yes	Yes	PORT OPR
21	157.050	157.050	Coast Guard	Yes	Yes	CCG
22	157.100	157.100	Coast Guard	Yes	Yes	USCG
23	157.150	157.150	Coast Guard	Yes	Yes	USCG
24	157.200	161.800	Public Corresp,Duplex	No	Yes	TELEPHONE
25	157.250	161.850	Public Corresp,Duplex	No	Yes	TELEPHONE
26	157.300	161.900	Public Corresp,Duplex	No	Yes	TELEPHONE
27	157.350	161.950	Public Corresp,Duplex	No	Yes	TELEPHONE
28	157.400	162.000	Public Corresp,Duplex	No	Yes	TELEPHONE
60						
61	156.075	156.075				CCG
62						
63	156.175	156.175				VTS
64	156.225	156.225				COMMERCIAL
65	156.275	156.275	Port Ops	Yes	Yes	PORT OPR
66	156.325	156.325	Port Ops	Yes	Yes	PORT OPR
67	156.375	156.375	Com'l, TX 1W only	Yes	No	BRG/BRG
68	156.425	156.425	Non Com'l	Yes	Yes	SHIP-SHIP
69	156.475	156.475	Non Com'l	Yes	Yes	PLEASURE
70	156.525	156.525				DSC
71	156.575	156.575	Non Com'l	Yes	Yes	PLEASURE
72	156.625	156.625	Non Com'l	Yes	No	SHIP-SHIP
73	156.675	156.675	Port Ops	Yes	Yes	PORT OPR
74	156.725	156.725	Port Ops	Yes	Yes	PORT OPR
77	156.875	156.875	Port Ops	Yes	No	PORT OPR
78	156.925	156.925	Non Com'l	Yes	Yes	SHIP-SHIP
79	156.975	156.975	Com'l	Yes	Yes	SHIP-SHIP
80	157.025	157.025	Com'l	Yes	Yes	SHIP-SHIP
81	157.075	157.075	Coast Guard	Yes	Yes	CCG
82	157.125	157.125	US Govt Only	Yes	Yes	CCG
83	157.175	157.175	Coast Guard	Yes	Yes	USCG
84	157.225	161.825	Public Corresp,Duplex	No	Yes	TELEPHONE
85	157.275	161.875	Public Corresp,Duplex	No	Yes	TELEPHONE
86	157.325	161.925	Public Corresp,Duplex	No	Yes	TELEPHONE
87	157.375	161.975	Public Corresp,Duplex	No	Yes	TELEPHONE
88	157.425	157.425	Com'l	Yes	No	COMMERCIAL

VHF FM Marine Radio Telephone

Channel and Functions

(International Channels)

CHANNEL DESIG	FREQUENCY (MHz)		TYPE OF TRAFFIC	SHIP TO SHIP	SHIP TO SHORE	CH TAG
	TRANSMIT	RECEIVE				
WX0	—	163.275	NOAA Weather	RX Only	RX Only	
WX1	—	162.550	NOAA Weather	RX Only	RX Only	
WX2	—	162.400	NOAA Weather	RX Only	RX Only	
WX3	—	162.475	NOAA Weather	RX Only	RX Only	
WX4	—	162.425	NOAA Weather	RX Only	RX Only	
WX5	—	162.450	NOAA Weather	RX Only	RX Only	
WX6	—	162.500	NOAA Weather	RX Only	RX Only	
WX7	—	162.525	NOAA Weather	RX Only	RX Only	
WX8	—	161.650	Can. Weather	RX Only	RX Only	
WX9	—	161.775	Can. Weather	RX Only	RX Only	
01	156.050	160.650	VTS,Duplex	Yes	Yes	TELEPHONE
02	156.100	160.700	Port Ops,Duplex	Yes	Yes	TELEPHONE
03	156.150	160.750	Port Ops,Duplex	Yes	Yes	TELEPHONE
04	156.200	160.800	Port Ops,Duplex	Yes	Yes	INTL
05	156.250	160.850	VTS,Duplex	Yes	Yes	INTL
06	156.300	156.300	Safety	Yes	No	SAFETY
07	156.350	160.950	Com',Duplexl	Yes	Yes	INTL
08	156.400	156.400	Com'l	Yes	No	COMMERCIAL
09	156.450	156.450	Com'l & Non Com'l	Yes	Yes	CALLING
10	156.500	156.500	Com'l	Yes	Yes	COMMERCIAL
11	156.550	156.550	Com'l	Yes	Yes	VTS
12	156.600	156.600	Port Ops	Yes	Yes	VTS
13	156.650	156.650	Navigational	Yes	Yes	BRG/BRG
14	156.700	156.700	Port Ops	Yes	Yes	VTS
15	156.750	156.750	Environmental	Yes	Yes	COMMERCIAL
16	156.800	156.800	Safety Calling	Yes	Yes	DISTRESS
17	156.850	156.850	State Control	Yes	Yes	SAR
18	156.900	161.500	Com'l,Duplex	Yes	Yes	INTL
19	156.950	161.550	Com'l,Duplex	Yes	Yes	INTL
20	157.000	161.600	Port Ops,Duplex	Yes	Yes	PORT OPR
21	157.050	161.650	Coast Guard,Duplex	Yes	Yes	INTL
22	157.100	161.700	Coast Guard,Duplex	Yes	Yes	INTL
23	157.150	161.750	Coast Guard,Duplex	Yes	Yes	INTL
24	157.200	161.800	Public Corresp,Duplex	No	Yes	TELEPHONE
25	157.250	161.850	Public Corresp,Duplex	No	Yes	TELEPHONE
26	157.300	161.900	Public Corresp,Duplex	No	Yes	TELEPHONE
27	157.350	161.950	Public Corresp,Duplex	No	Yes	TELEPHONE
28	157.400	162.000	Public Corresp,Duplex	No	Yes	TELEPHONE
60	156.025	160.625	Duplex			TELEPHONE
61	156.075	160.675	Duplex			INTL
62	156.125	160.725	Duplex			INTL
63	156.175	160.775	Duplex			INTL
64	156.225	160.825	Duplex			TELEPHONE
65	156.275	160.875	Port Ops,Duplex	Yes		INTL
66	156.325	160.925	Port Ops,Duplex	Yes	Yes	INTL
67	156.375	156.375	Com'l	Yes	No	BRG/BRG
68	156.425	156.425	Non Com'l	Yes	Yes	SHIP-SHIP
69	156.475	156.475	Non Com'l	Yes	Yes	PLEASURE
70	156.525	156.525				DSC
71	156.575	156.575	Non Com'l	Yes	Yes	PLEASURE
72	156.625	156.625	Non Com'l	Yes	No	SHIP-SHIP
73	156.675	156.675	Port Ops	Yes	Yes	PORT OPR
74	156.725	156.725	Port Ops	Yes	Yes	PORT OPR
77	156.875	156.875	Port Ops	Yes	No	PORT OPR
78	156.925	161.525	Non Com'l,Duplex	Yes	Yes	INTL
79	156.975	161.575	Com'l,Duplex	Yes	Yes	INTL
80	157.025	161.625	Com'l,Duplex	Yes	Yes	INTL
81	157.075	161.675	Coast Guard,Duplex	Yes	Yes	INTL
82	157.125	161.725	US Govt Only,Duplex	Yes	Yes	INTL
83	157.175	161.775	Coast Guard,Duplex	Yes	Yes	INTL
84	157.225	161.825	Public Corresp,Duplex	No	Yes	TELEPHONE
85	157.275	161.875	Public Corresp,Duplex	No	Yes	TELEPHONE
86	157.325	161.925	Public Corresp,Duplex	No	Yes	TELEPHONE
87	157.375	161.975	Public Corresp,Duplex	No	Yes	TELEPHONE
88	157.425	162.025	Com'l,Duplex	Yes	No	TELEPHONE

VHF FM Marine Radio Telephone Channel and Functions (Canadian Channels)

CHANNEL DESIG	FREQUENCY (MHz)		TYPE OF TRAFFIC	SHIP TO SHIP	SHIP TO SHORE	CH TAG
	TRANSMIT	RECEIVE				
WX0	—	163.275	NOAA Weather	RX Only	RX Only	
WX1	—	162.550	NOAA Weather	RX Only	RX Only	
WX2	—	162.400	NOAA Weather	RX Only	RX Only	
WX3	—	162.475	NOAA Weather	RX Only	RX Only	
WX4	—	162.425	NOAA Weather	RX Only	RX Only	
WX5	—	162.450	NOAA Weather	RX Only	RX Only	
WX6	—	162.500	NOAA Weather	RX Only	RX Only	
WX7	—	162.525	NOAA Weather	RX Only	RX Only	
WX8	—	161.650	Can. Weather	RX Only	RX Only	
WX9	—	161.775	Can. Weather	RX Only	RX Only	
01	156.050	160.650	Duplex	Yes	Yes	TELEPHONE
02	156.100	160.700	Duplex	Yes	Yes	TELEPHONE
03	156.150	160.750	Duplex	Yes	Yes	TELEPHONE
04	156.200	156.200		Yes	Yes	INTL
05	156.250	156.250		Yes	Yes	VTB
06	156.300	156.300		Yes	No	SAFETY
07	156.350	156.350		Yes	Yes	COMMERCIAL
08	156.400	156.400		Yes	No	COMMERCIAL
09	156.450	156.450		Yes	Yes	CALLING
10	156.500	156.500		Yes	Yes	COMMERCIAL
11	156.550	156.550		Yes	Yes	VTB
12	156.600	156.600		Yes	Yes	VTB
13	156.650	156.650	1W	Yes	Yes	BRG/BRG
14	156.700	156.700		Yes	Yes	VTB
15	156.750	156.750	1W	Yes	Yes	COMMERCIAL
16	156.800	156.800		Yes	Yes	DISTRESS
17	156.850	156.850	1W	Yes	Yes	SAR
18	156.900	156.900		Yes	Yes	COMMERCIAL
19	156.950	156.950		Yes	Yes	COMMERCIAL
20	157.000	161.600	Duplex, 1W	Yes	Yes	PORT OPR
21	157.050	157.050		Yes	Yes	CCG
22	157.100	157.100		Yes	Yes	USCG
23	157.150	161.750	Duplex	Yes	Yes	INTL
24	157.200	161.800	Duplex	No	Yes	TELEPHONE
25	157.250	161.850	Duplex	No	Yes	TELEPHONE
26	157.300	161.900	Duplex	No	Yes	TELEPHONE
27	157.350	161.950	Duplex	No	Yes	TELEPHONE
28	157.400	162.000	Duplex	No	Yes	TELEPHONE
60	156.025	160.625	Duplex			TELEPHONE
61	156.075	156.075				CCG
62	156.125	156.125				INTL
63	—	—				
64	156.225	156.225	Simplex			COMMERCIAL
65	156.275	156.275		Yes	Yes	PORT OPR
66	156.325	156.325		Yes	Yes	PORT OPR
67	156.375	156.375		Yes	No	BRG/BRG
68	156.425	156.425		Yes	Yes	SHIP-SHIP
69	156.475	156.475		Yes	Yes	PLEASURE
70	156.525	156.525				DSC
71	156.575	156.575		Yes	Yes	PLEASURE
72	156.625	156.625		Yes	No	SHIP-SHIP
73	156.675	156.675		Yes	Yes	PORT OPR
74	156.725	156.725		Yes	Yes	PORT OPR
77	156.875	156.875		Yes	No	PORT OPR
78	156.925	156.925		Yes	Yes	SHIP-SHIP
79	156.975	156.975		Yes	Yes	SHIP-SHIP
80	157.025	157.025		Yes	Yes	SHIP-SHIP
81	157.075	157.075		Yes	Yes	CCG
82	157.125	157.125		Yes	Yes	CCG
83	157.175	157.175		Yes	Yes	USCG
84	157.225	161.825	Duplex	No	Yes	TELEPHONE
85	157.275	161.875	Duplex	No	Yes	TELEPHONE
86	157.325	161.925	Duplex	No	Yes	TELEPHONE
87	157.375	161.975	Duplex	No	Yes	TELEPHONE
88	157.425	162.025	Duplex	Yes	No	TELEPHONE

NWR-SAME EVENT CODE

Event Code	Standard	EVENT LEVEL (Siren Type)				LCD Display
		Warning	Watch	Statement	Test	
Emergency Action Notification	EAN	0				EMG NOTIFY
Emergency Action Termination	EAT	0				EMG END
National Information Center	NIC	0				NATION INFO
Tornado Warning #	TOW (or TOR)	0				TORNADO
Severe Thunderstorm Warning #	SVW (or SVR)	0				THUNDERSTORM
Flash Flood Warning	FFW	0				FLASH FLOOD
Flood Warning	FLW	0				FLOOD
Winter Storm Warning	WSW	0				WINTER STORM
Blizzard Warning	BZW	0				BLIZZARD
High Wind/Dust Storm Warning	HWV	0				HIGH WIND
Radiological Hazard Warning	RHW	0				RADIOLOGICAL
Civil Danger Warning	CDW	0				CIVILDANGER
Local Area Emergency	LAE	0				LOCAL EMG
Hazardous Material Warning	HMW	0				HAZARDOUS
Civil Emergency Message	CEM	0				CIVIL EMG
Immediate Evacuation Warning	IEW	0				EVACUATION
Immediate Evacuation Notice	EVI	0				EVACUATENOTE
Law Enforcement Warning	LEW	0				LAW ENFORCE
Fire Warning	FRW	0				FIRE
Hurricane/Tropical Storm Warning	HUV	0				HURRICANE
Tsunami Warning	TSW	0				TSUNAMI
Coastal Flood Warning	CFW	0				COAST FLOOD
Special Marine Warning	SMW	0				SPECIAL MRN
Avalanche Warning	AVW	0				AVALANCHE
Volcano Warning	VOW	0				VOLCANO
Shelter In Place Warning	SPW	0				SHELTER
Civil Danger Watch	CDA		0			CIVIL DANGER
Radiological Hazard Watch	RHA		0			RADIOLOGICAL
Hazardous Material Watch	HMA		0			HAZARDOUS
Winter Storm Watch	WSA		0			WINTER STORM
High Wind/Dust Storm Watch	HWA		0			HIGH WIND
Tornado Watch	TOA		0			TORNADO
Severe Thunderstorm Watch	SVA		0			THUNDERSTORM
Flash Flood Watch	FFA		0			FLASH FLOOD
Flood Watch	FLA		0			FLOOD
Hurricane/Tropical Storm Watch	HUA		0			HURRICANE
Tsunami Watch	TSA		0			TSUNAMI
Coastal Flood Watch	CFA		0			COAST FLOOD
Avalanche Watch	AVA		0			AVALANCHE
Volcano Watch	VOA		0			VOLCANO
Severe Weather Statement	SVS			0		SEVERE WX
Special Weather Statement	SPS			0		SPECIAL WX
Flash Flood Statement	FFS			0		FLASH FLOOD
Flood Statement	FLS			0		FLOOD
Hurricane Statement	HLS			0		HURRICANE
National Periodic Test	NPT				0	NATIONPERIOD
Required Monthly Test	RMT				0	MONTHLY
Required Weekly Test	RWT				0	WEEKLY
System Demonstration/Practice	DMO					SYSTEM DEMO
NATIONAL HAZARD WARNING	NHW	0				NATIONHAZARD
UNKNOWN EMERGENCY TUNE TV	**E	0				UNKNOWN TV
UNKNOWN WARNING TUNE TV	**W	0				UNKNOWN TV
UNKNOWN WATCH TUNE TV	**A		0			UNKNOWN TV
UNKNOWN STATEMENT TUNE TV	**S			0		UNKNOWN TV

Specification

General

Channels	: Transmit 54 Receive 80 Marine/10 Weather
Controls	: On-Off/Volume, Squelch
Status Indicators	: TX (Transmit), TRI (Triple Watch), HI (High), LO (Low), U, C, I, MEM, WX, DSC, ☉ (Alarm), 📡 (Alert), 📍 (GPS), 📻 (WHAM), and Channel Display
Channel Display	: LCD with Orange backlight
Buttons	: 16/9/TRI, DISTRESS, PA, UIC/MEM, SELECT, STEP/SCAN, H/L/MENU, WX/ALERT
Connectors	: Antenna, Remote, ACC, and DC power
Size	: H63 mm x W160 mm x L168 mm (W/O Heat Sink) H3.07 inches x W7.24 inches x L6.61 inches
Weight	: 1.0 kg / 2.65 lbs / 42.3 oz
Supply Voltage	: 13.8V DC negative ground
Standard Accessories	: Mounting bracket and hardware, DC power cord, microphone hanger, spare fuse, ACC Cable
Antenna Impedance	: 50 Ω nominal
Microphone	: Rugged 2 k Ω condenser mic element with coiled cord
Speaker	: 1.82 inch, Mylar Cone 8 Ω
Operating Temperature Range	: -20 °C to + 50 °C (-4 °F to +122 °F)
Shock and Vibration	: Meets or exceeds EIA standards, RS152B and RS204C
FCC Approvals	: Type accepted under part 80 of the Rules; meets Great Lakes Agreement and party boat requirements

Transmitter

Power Output	: 1 watt or 25 watt (switch selectable)
Power Requirement	: Not rated on LO, 25 watts output: 5.6A@13.8V DC
Modulation	: FM ± 5 kHz deviation (FCC designator F3E)
Hum and Noise Signal-to-Noise	: 45 dB@1 kHz with 3 kHz deviation with 1000 Hz modulating frequency (nominal)
Audio Distortion	: Less than 8% with 3 kHz deviation with 1000 Hz modulating frequency
Spurious Suppression	: -25 dBm @ Hi, -29 dBm @ Lo
Output Power Stabilization	: Built-in automatic level control (ALC)
Frequency Range	: 156 to 158 MHz
Frequency Stability	: ± 5 ppm @ -20°C to + 50°C

Receiver

Frequency Range	: 156 to 163 MHz
Sensitivity	: 0.25 μ V for 12 dB SINAD
Circuit	: Dual Conversion Super Heterodyne PLL
Squelch Sensitivity	: 0.5 μ V Threshold
Spurious Response	: 65 dB
Adjacent Channel Selectivity	: 65 dB @ ± 25 kHz
Audio Output Power	: 2.8 watts (10% Distortion)
Power Requirement	: 200 mA @ 13.8V DC squelched, 0.7A @ 13.8V DC at maximum audio output
IF Frequencies	: 1st 21.4 MHz, 2nd -455 kHz

Troubleshooting

If the **OCEANUS DSC** does not perform to your expectations, try the suggestions listed below. If you cannot get satisfactory results, call the Uniden Technical Support at (800) 586-0409, 8:00 a.m. to 5:00 p.m., Central Standard Time, Monday through Friday.

SYMPTOM	CAUSE	REMEDY
Won't power On.	No or low voltage.	Check for proper voltage getting to the set.
When the PTT is pressed - Tx icon comes on and another radio can hear a "click" but no audio is heard.	Bad mic element.	Send in for repair.
While scanning, the radio stops on a particular channel all of the time.	A source of noise is nearby.	Eliminate the source of the noise or delete the channel from the scanner.
There is noise on the receiver that the squelch will not eliminate.	An external noise is being generated by some device.	Either turn off the offending device or contact that Mfg. Regarding FCC part 15 "unintentional radiator".

Care and Maintenance

Your **OCEANUS DSC** is a precision of electronic equipment and you should treat it accordingly. Due to the rugged design, very little maintenance is required. However, a few precautions should be observed:

- If the antenna has been damaged, you should not transmit except in the case of an emergency. A defective antenna may cause damage to your radio.
- You are responsible for continued FCC technical compliance of your radio.
- You are urged to arrange for periodic performance checks with your Uniden Marine dealer.

Note

Note

Three Year Limited Warranty

WARRANTOR: UNIDEN AMERICA CORPORATION (“Uniden”)

ELEMENTS OF WARRANTY: Uniden warrants, for three years, to the original retail owner, this Uniden Product to be free from defects in materials and craftsmanship with only the limitations or exclusions set out below.

WARRANTY DURATION: This warranty to the original user shall terminate and be of no further effect 36 months after the date of original retail sale. The warranty is invalid if the Product is (A) damaged or not maintained as reasonable or necessary, (B) modified, altered, or used as part of any conversion kits, subassemblies, or any configurations not sold by Uniden, (C) improperly installed, (D) serviced or repaired by someone other than an authorized Uniden service center for a defect or malfunction covered by this warranty, (E) used in any conjunction with equipment or parts or as part of any system not manufactured by Uniden, or (F) installed or programmed by anyone other than as detailed by the Operating Guide for this product.

STATEMENT OF REMEDY: In the event that the product does not conform to this warranty at any time while this warranty is in effect, warrantor will repair the defect and return it to you without charge for parts, service, or any other cost (except shipping and handling) incurred by warrantor or its representatives in connection with the performance of this warranty. THE LIMITED WARRANTY SET FORTH ABOVE IS THE SOLE AND ENTIRE WARRANTY PERTAINING TO THE PRODUCT AND IS IN LIEU OF AND EXCLUDES ALL OTHER WARRANTIES OF ANY NATURE WHATSOEVER, WHETHER EXPRESS, IMPLIED OR ARISING BY OPERATION OF LAW, INCLUDING, BUT NOT LIMITED TO ANY IMPLIED WARRANTIES OF MERCHANTABILITY OR FITNESS FOR A PARTICULAR PURPOSE. THIS WARRANTY DOES NOT COVER OR PROVIDE FOR THE REIMBURSEMENT OR PAYMENT OF INCIDENTAL OR CONSEQUENTIAL DAMAGES. Some states do not allow this exclusion or limitation of incidental or consequential damages so the above limitation or exclusion may not apply to you.

LEGAL REMEDIES: This warranty gives you specific legal rights, and you may also have other rights which vary from state to state. This warranty is void outside the United States of America.

PROCEDURE FOR OBTAINING PERFORMANCE OF WARRANTY: If, after following the instructions in this Operating Guide you are certain that the Product is defective, pack the Product carefully (preferably in its original packaging). Include evidence of original purchase and a note describing the defect that has caused you to return it. The Product should be shipped freight prepaid, by traceable means, or delivered, to warrantor at:

**Uniden America Corporation
Parts and Service Division
4700 Amon Carter Blvd.
Ft. Worth, TX 76155
(800) 235-3874, 8 AM to 5 PM Central,
Monday through Friday**

Thank you for purchasing a Uniden Marine Radio.

A World Without Wires® | **Uniden**®
www.uniden.com

FCC WANTS YOU TO KNOW

Changes or modifications to this product not expressly approved by Uniden, or operation of this product in any way other than as detailed by the owner's manual, could void your authority to operate this product.

© 2003 Uniden America Corporation, Fort Worth, TX
All rights reserved.
Contains additional foreign articles.

Custom manufactured in China.

UTZZ01910ZZ