

Uniden[®]

CLX 465

SERIES

OWNER'S

MANUAL

OWNER'S MANUAL

Contents

Welcome/Features/Terminology	2	Using Your Phone	37	Checking the number of stored entries	57
Controls & Functions	4	Making Calls	37	Changing the sorting order	57
Setting up the Phone	6	Receiving a call	39	Naming phonebook groups	58
Choose the best location	6	Hanging Up	39	Making Calls with the Phonebook	58
Optional Battery Backup Feature	7	Switching to the Handset		Caller ID Features	59
Install the rechargeable battery pack	8	Speakerphone During a Call	39	Using the Caller ID List	59
Low battery alert	9	Moving out of range	40	Deleting Caller ID numbers	60
Cleaning the battery charging contacts	9	Call Waiting	40	Multi-Handset Features	61
Connect the base and charge the handset	10	Call Waiting Deluxe	40	Using DirectLink Mode	61
Mounting the Base Unit on a Wall	11	Placing a Call on Hold	41	Room/Baby Monitor	62
Standard wall plate mounting	11	Conferencing	42	Intercom	63
Expanding Your Phone	12	Redialing Calls	43	Transferring a Call	64
Backwards/Forwards		Adjusting Base Ringer and Speaker		Note on Power Sources	65
Compatibility	12	Volumes	44	Power Failure	65
Connect the expansion handset's charger	13	Using the Handset Volume		Battery replacement and handling	65
Register the Handset	13	Options	45	Warning	65
Register the TCX440 and TCX400 expansion handset to main base	14	Mute	46	General Information	66
Changing the Digital Security Code	15	Mute the Microphone	46	AC Adapter Information	66
Installing the Beltclip	15	Tone Dialing Switch Over	47	Battery Information	66
Optional Headset Installation	16	Privacy Mode	47	Troubleshooting	67
Installing Uniden's Cordless Telephone Customization Tool	16	Do Not Disturb (DND)	47	System Reset	69
Using the Interface	18	Find Handset	48	Liquid Damage	70
Example of the standby mode display	18	Using One Touch Voice Mail Access	48	Precautions & Warranty	71
Display Icons	19	Programming your Voice Mail Access Number	48	I.C. Notice	73
Soft Key Function	20	Voice Mail Tone	49	Index	74
Using the joystick	21	Resetting the New Message LED for Base	49		
Entering text	22	Reminder (Handset only)	50		
Main Menu Options	23	Using the Phonebook	52		
System Setup Menu	24	Creating and Editing Phonebook Entries	52		
		Storing Caller ID or Redial Numbers in the Phonebook	55		
		Managing the Phonebook	56		

Welcome

Features

Thank you for purchasing a Uniden Multi-Handset phone. The USB connection lets you use your personal computer to edit your phonebook, download schedule reminders, and even import contacts from Microsoft Outlook[®].

Note: Illustrations in this manual are used for explanation purposes. Some illustrations in this manual may differ from the actual unit.



As an Energy Star[®] Partner, Uniden has determined that this product or product models meets the Energy Star[®] guidelines for energy efficiency. Energy Star[®] is a U.S. registered mark.

- 5.8GHz Digital Expandable System
- Caller ID/Call Waiting Deluxe Options
- Customize Handset Profiles Using Personal Computer
- 100 Phonebook Names (4 Numbers Per Name)
- Downloadable Images
- Recordable Ringer Tones
- Calendar with Schedule Reminder Capability
- Battery Backup During Power Failure (optional)

Uniden[®] is a registered trademark of Uniden America Corporation. AutoStandby, DirectLink, IntegriSound and Random Code are trademarks of Uniden America.

Microsoft and Windows are either registered trademarks or trademarks of Microsoft Corporation in the United States and/or other countries.

Terminology

- **Standby mode:** The handset is not in use. If it is off the cradle, no line has been activated. No dial tone is present.
- **Talk mode:** A telephone line has been activated on the handset, enabling a dial tone.

Accessibility

Uniden provides a customer service hotline for accessibility questions. If you have a disability and need customer service assistance or if you have any questions about how Uniden's products can accommodate persons with disabilities, please call the accessibility voice/TTY line:

1-800-874-9314

A representative is available to talk to you M-F, 8:00 am to 5:00 pm, CST. After hours, you can leave us a message, and we will call you back. Information is also available on our website, www.uniden.com, under the "Accessibility" link.

Controls & Functions

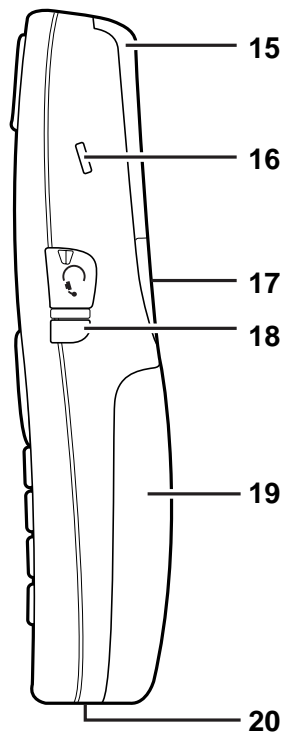
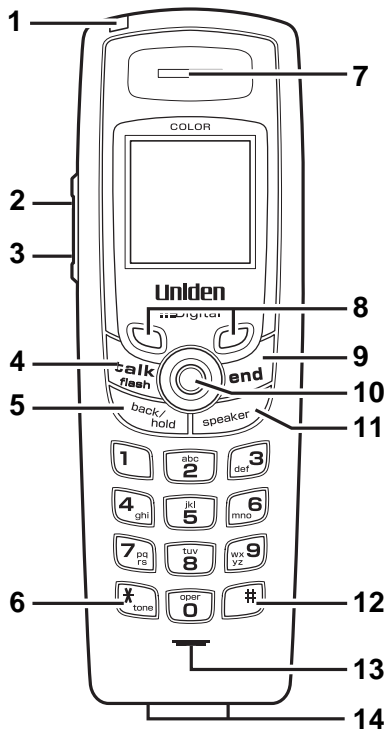

1. New Message LED
2. Volume Δ (up) (P. 46)
3. Volume ∇ (down) (P. 46)
4. Talk/flash (P. 37 & 40)
5. Back/hold/intercom (P. 21, 41 & 63)
6. */tone (P. 60 & 47)
7. Ear Speaker
8. Soft menu keys (P. 20)
9. end (P. 39)
10. Joystick (P. 21)
11. Speaker Phone (P. 38)
12. # (P. 60)
13. Handset Microphone
14. Handset Charging Contacts
15. Handset Antenna
16. Beltclip Hole
17. Speakerphone Speaker and Ringer
18. Headset Jack
19. Handset Battery Compartment
20. USB jack

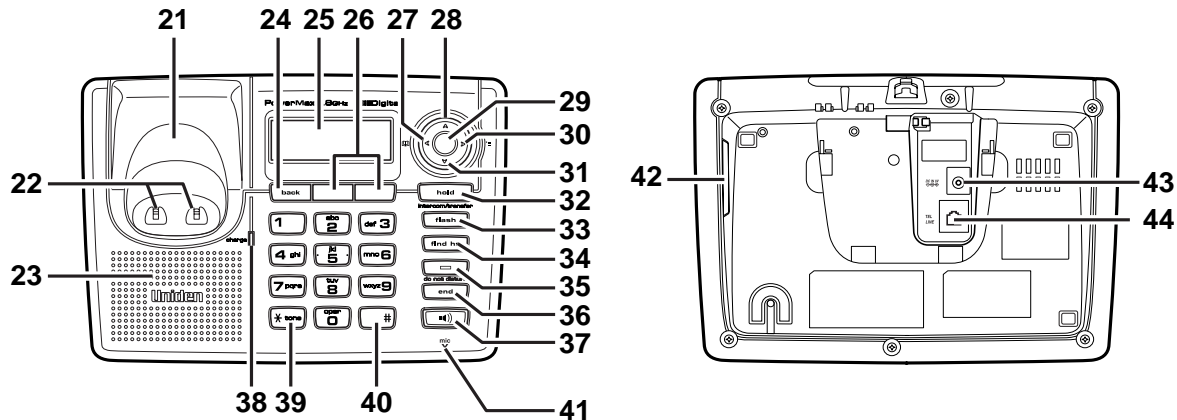

- 21. Base Antenna
- 22. Base Charge Contacts
- 23. Base Speaker
- 24. Back (P. 21)
- 25. LCD Display
- 26. Soft Menu keys (P. 20)
- 27. Phonebook/< (P. 52 & 21)
- 28. Δ /Speaker Volume Up (P. 21 & 44)
- 29. Menu/select (P. 21)

- 30. \equiv (Caller ID)/> (P. 60 & 21)
- 31. ∇ /Speaker Volume Down (P. 21 & 44)
- 32. Hold/intercom/transfer (P. 41 & 63 & 64)
- 33. Flash (P. 40)
- 34. Find hs (P. 48)
- 35. Do not disturb (DND) (P. 47)/Dnd LED
- 36. End (P. 39)

- 37. Speaker (P. 38) / Speaker LED
- 38. Handset charge LED
- 39. */tone (P. 47 & 60)
- 40. # (P. 60)
- 41. Base Microphone
- 42. Backup Battery Compartment
- 43. DC IN 9V Jack
- 44. TEL LINE Jack



For maximum range:

- Do not hold the handset where you might block the signal.

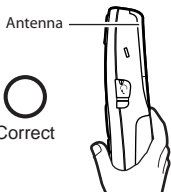

Correct

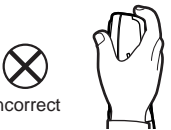

Incorrect

- Metal and reinforced concrete may affect cordless telephone performance.

Setting up the Phone

Choose the best location

When choosing a location for your new phone, here are some important guidelines you should consider:

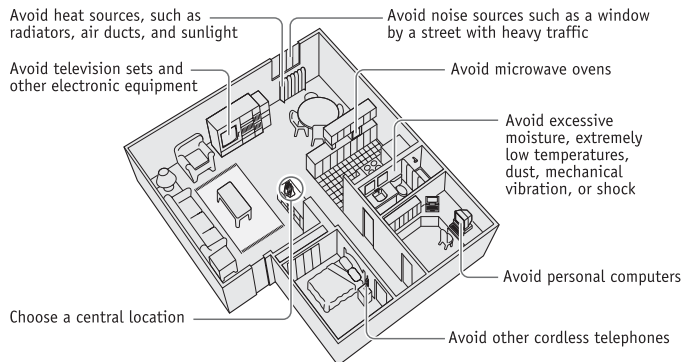

- The location should be close to both a phone jack and a continuous power outlet (one which is not connected to a switch).
- The base and handset should be kept away from sources of electrical noise such as motors, Microwave ovens, and fluorescent lighting.
- For better reception, place the base as high as possible.
- The base should be placed in an open area for optimum range and reception.
- If your home has specially wired alarm equipment connected to your phone line, be sure that installing the system does not disable your alarm equipment.
- If you have questions about what will disable alarm equipment, contact your telephone company or a qualified installer.
- The base should be placed in an open area for optimum range and reception.

Optional Battery Backup Feature

The battery backup allows you to make and receive calls during a power failure. You can use any handset or the base, just as you would normally.

Install the backup battery in the base

- 1) Open the battery case cover by pressing in slightly on the right side of the base as shown.
- 2) Place the battery pack in the battery compartment with the connectors on the battery and on the compartment aligned.
- 3) Push in the battery compartment.



-  appears in LCD as a warning that the backup battery pack is NOT installed in the base unit.
- To use the backup battery Feature you need to connect the AC adapter to the base, and charge the base battery for at least 24 hours.
- Use only the Uniden (BT-0003) rechargeable battery pack. The battery may be purchased by calling Uniden's Parts Department (see back cover page).



Use only the Uniden (BT-0003) rechargeable battery pack supplied with your cordless telephone.

Install the rechargeable battery pack

- 1) Press down on the handset battery case cover (use the finger indentation for a better grip) and slide the cover downward to remove.
- 2) Place the battery pack in the battery compartment with the connectors on the battery and on the compartment aligned.
- 3) Place the battery case cover back on the handset and slide it upwards until it clicks into place.

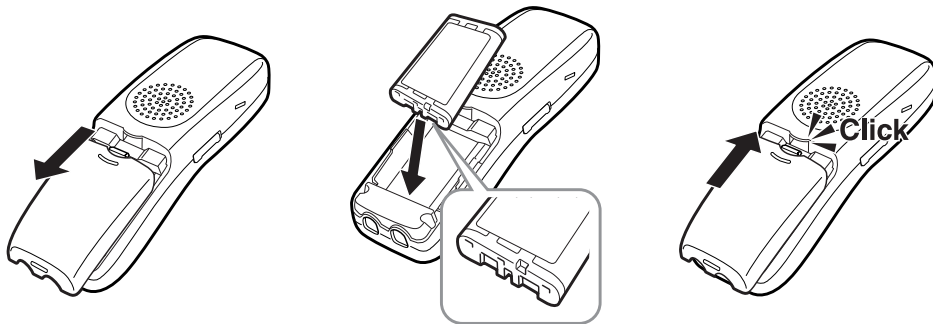

Low battery alert

When the battery pack is very low, the phone is programmed to eliminate functions in order to save power.

The battery pack needs to be charged when:

- The empty battery icon appears.
- Low Battery appears in the display.

If the phone is in standby mode, none of the keys will operate. If you are on a call, complete your conversation as quickly as possible, and return the handset to the cradle.

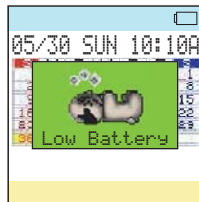

Cleaning the battery charging contacts

To maintain a good charge, clean the charging contacts on the handset once a month. Dampen a cloth with plain water. Gently rub the damp cloth over the charging contacts until all visible dirt is removed. Dry the contacts thoroughly before returning the handset to the cradle.

Caution: Do not use paint thinner, benzene, alcohol, or other chemical products. Doing so may discolor the surface of the telephone and damage the finish.

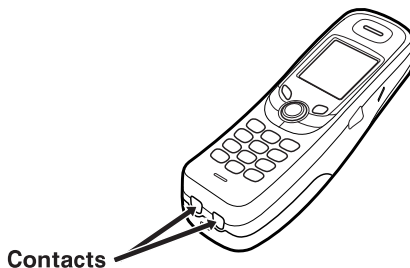

- Even when the battery pack is not being used, it will gradually discharge over a long period of time.
- For optimum performance, be sure to return the handset to the cradle after each telephone call.
- If the handset is left off the base, the actual talk mode duration will be reduced respective to the amount of time the handset is off the cradle.



• Use only the supplied AD-0006 AC adapter. Do not use any other AC adapter.

• Do not place the power cord where it creates a trip hazard or where it could become chafed and create a fire or electrical hazard.

• Don't place the base in direct sunlight or subject it to high temperatures. The battery may not charge properly.



If your telephone outlet isn't modular, contact your telephone company.

Connect the base and charge the handset

- 1) Connect the AC adapter to the **DC IN 9V** jack.

Place the base close to the AC outlet to avoid long extension cords.

- 2) Connect the AC adapter to a continuous power supply (i.e., an outlet that is not controlled by a switch).
- 3) Close the handset and place it in the base with the handset facing forward.
- 4) Make sure that the **charge** LED illuminates. If the LED does not illuminate, check to see that the AC adapter is plugged in and the handset makes good contact with the base charging contacts.
- 5) **Charge your handset at least 15 hours before plugging into the phone line.**
- 6) Once the handset battery pack is fully charged, connect the telephone line cord to the **TEL LINE** jack and to a telephone outlet.

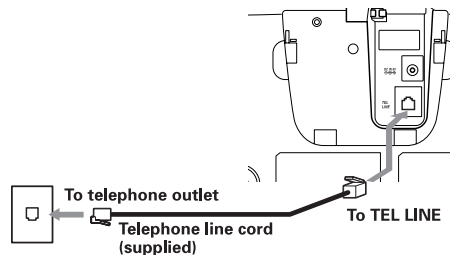
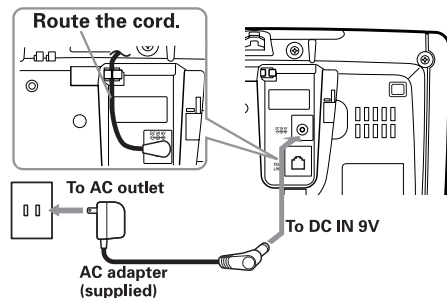

Mounting the Base Unit on a Wall

Standard wall plate mounting

This phone can be mounted on any standard wall plate.

- 1) Plug the AC adapter into the DC IN 9V jack.
- 2) Plug the telephone line cord into the TEL LINE jack.
Wrap the cord inside the molded wiring channel as shown.
- 3) Snap the wall mount adapter into the notches on the base top.
- 4) Wrap the AC adapter cord and telephone line cord inside the molded wiring channel as shown.
- 5) Plug the AC adapter into a standard 120V AC wall outlet.
- 6) Plug the telephone line cord into the telephone outlet.
- 7) Align the mounting slots on the base with the mounting posts on the wall. Then push in and down until the phone is firmly seated.

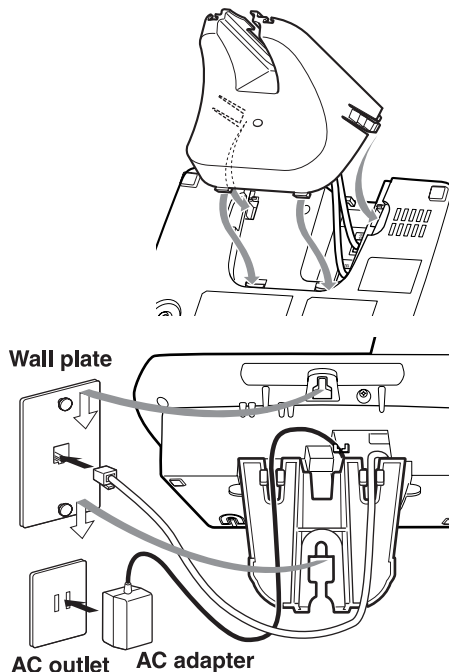

DO NOT use an AC outlet controlled by a wall switch.



- Advanced features may not be supported by older handsets.
- If you have any trouble with your phone, visit our web site at www.uniden.com or call our Customer Hotline at 1- 800-297-1023 (Mon -Fri 7 am to 7pm, Sat/Sun 9 am to 5pm, CST). (The Customer Service Hotline is closed on holidays.)

Expanding Your Phone

Your phone can support a total of ten handsets. Expansion handsets do not need to be connected to a phone jack, and allow you to use additional features such as DirectLink Mode and up to 4-way conference calling. Expansion handsets need to be registered to the base before they will operate.

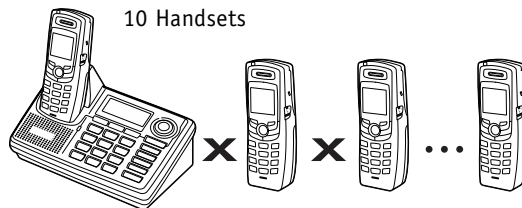

Backwards/Forwards Compatibility

Your phone is compatible with other Uniden 5.8GHz Digital Expandable Handsets. Compatible models include the **TCX400**, **TCX440**, **ELX500**, **TCX805**, and **TCX860**. (Please check www.uniden.com for an updated list of expansion handsets compatible with this series.)



Connect the expansion handset's charger

The handset's the battery recharges automatically when the handset is placed in the charger.

- 1) Connect the AC adapter to the DC IN 9V jack and to a standard 120V AC wall outlet.
- 2) Set the charger on a desk or tabletop, and place the handset in the charger with the handset facing forward.
- 3) Make sure that the **charge** LED illuminates. If the LED does not illuminate, check to see that the AC adapter is plugged in and the handset makes good contact with the charger charging contacts.
- 4) Charge the handset battery pack for at least 15 hours before using your new cordless telephone for the first time.

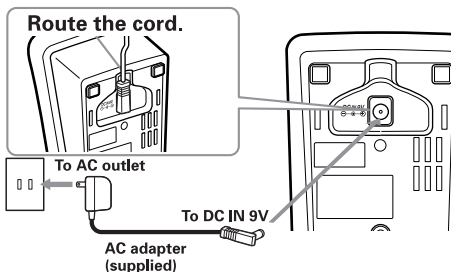

•Use only the supplied AD-0005 AC adapter. Do not use any other AC adapter.

•Your phone may be compatible with other Uniden 5.8Ghz Digital Expandable Systems. Look for the technology icon on our boxes or visit our website for a list of compatible models.

Register the Handset

Handsets supplied with the phone are registered to the base by the factory. Pre-registered handsets display a handset ID number. Handsets that have not been registered display **MUST** place the handset in base to register! Models may vary, refer to Owners Manual for help. in the LCD. When you register an extra handset to the base, the handset ID will be assigned. Only one handset can be registered at a time.

Register the TCX440 and TCX400 expansion handset to main base

Before an expansion handset is registered, the battery pack **MUST** be charged for **15 hours**.

To register TCX440 or TCX400 handset, simply place it in the main base.

While the handset is registering, `Handset Registering` will appear in the LCD. When `Registration complete.` is displayed, the handset has been registered to the base. If `Registration failed.` appears, please try these steps again.

To register a TCX805, TCX860, ELX500 handset, follow the steps below:

- 1) From the base, press *menu/select* and select `System Setup` menu.
- 2) Select `Register Handset`, and press *menu/select*.
- 3) On the handset, press and hold # until you hear a beep.



While the handset is registering, `Handset Registering` will appear in the LCD. When `Registration complete.` is displayed, the handset has been registered to the base. If `Registration failed.` appears, please try these steps again.

Changing the Digital Security Code

The digital security code is an identification code used to connect the handset and the base unit. Normally, setting the code is not necessary. In the rare situation that you suspect another cordless telephone is using the same security code, you can change the code. To change the digital security code:

1. "System Reset" options ("De-register the Handset" and "Replacing the Base Setting") for all the handsets you have (see page 69).
2. Re-register each handset by following the steps on page 14.

Installing the Beltclip

To attach the beltclip

Insert the beltclip into the holes on each side of the handset. Press down until it clicks.

To remove the beltclip

Pull either side of the beltclip to release the tabs from the holes.

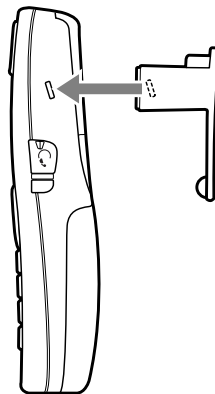

Optional Headset Installation

Your phone may be used with an optional headset. To use an optional headset, insert the headset plug into the headset jack. Your phone is ready for hands-free conversations. (Headsets may be purchased by calling Uniden's Parts Department. See back cover page.)

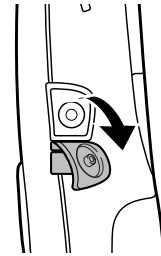

Installing Uniden's Cordless Telephone Customization Tool

This phone includes Uniden's Cordless Telephone Customization Tool for your Windows PC. You can use this software application to completely configure your phone, download pictures for wallpaper, and import contacts from Microsoft Outlook.

NOTE: Uniden's Cordless Telephone Customization Tool requires either Microsoft®, Windows® 98SE, Windows ME, Windows 2000, Windows XP and more than 150MB free hard drive space.

- 1) Insert the Cordless Telephone Customization Tool CD into your computer's CD-ROM drive. The installation application should start automatically.
- 2) If the application doesn't start, go to the **Start** menu and select **Run**.
- 3) In the window, type **d:\autorun.exe** (where **d** is the letter assigned to your CD-ROM drive), and click **OK**.
- 4) Once the software is installed, connect the USB cable to the handset and your PC as shown.
- 5) Customize your Uniden cordless handset with your personal preferences.

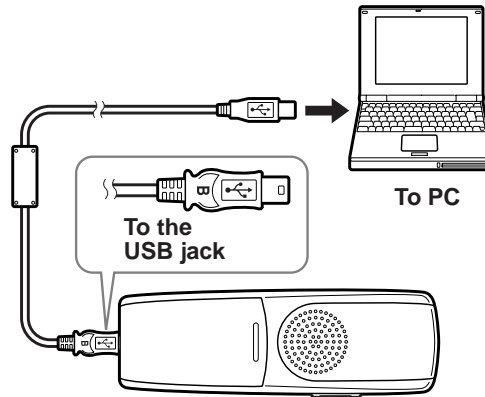

For complete instructions on using Uniden's Cordless Telephone Customization Tool, see the help file on the CD-ROM.

Using the Interface

Example of the standby mode display



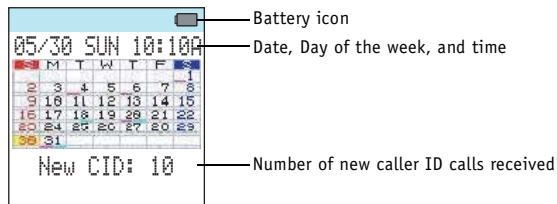



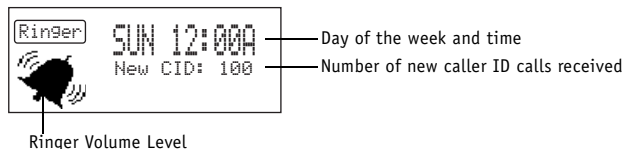





• Handset



• Base



Display Icons

ICON		DESCRIPTION
Handset	Base	
	-	Battery icons indicate the handset battery status. This icon cycles depending on the battery status (empty, low, medium, and full).
	-	Ringer off icon indicates that the ringer is turned off.
		Telephone icon indicates that the line is in use.
		Mute icon appears when you mute the handset or the base.
	-	Speaker icon appears when the handset speaker phone is use.
		Envelope icon appears when a new message is received.
		Privacy icon appears when the Privacy Mode is turned on.
		Call record icon appears while recording a conversation.

Soft Key Function

"Soft" keys are keys that change function during the operation of the phone. There are two soft keys on the handset and base.

The text right above the soft key indicates that key's current function. For example, when the phone is in standby mode, pressing soft key 2 on the handset makes a selection. When the phone is in talk mode, pressing soft key 2 brings up the options menu. Complete information on the features controlled by the soft keys can be found under each feature.

In standby mode

Handset



Soft key 2

In talk mode

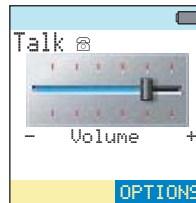

Soft key 2

Base

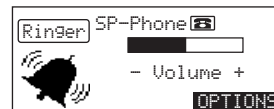
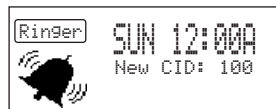

Soft key 2

Using the joystick

The joystick makes it easy to use your phone. The four most commonly used functions are accessible just by moving the joystick.

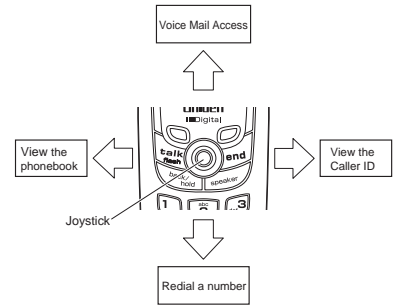

Use the joystick or *menu/select* key on the base to make menu selections.

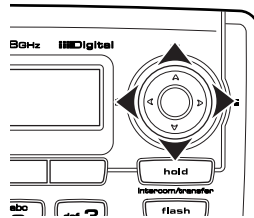
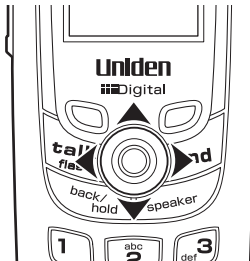

Highlight the option you want by moving the joystick up, down, right, or left on the handset, or up or down on the base. This will move the cursor; the option currently highlighted appears in reversed out text.

Select the highlighted option by pressing in on the center of the joystick or the *menu/select* key on the base.

To exit the **MENU** and return to standby, press the *end* key.

To go back a level in the menu, press *back/hold/intercom* or *back* on the base.

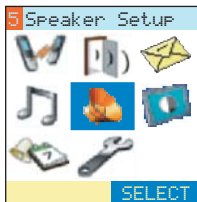

Entering text

You can use the number keypad on your phone to enter text by referring to the letters printed on each number key. When you press the number key in a text entry field, the phone displays the first letter printed on the number key. Press the number key twice to display the second letter and three times to display the third. Capital letters are displayed first, then lower case letters, then the number on the key.

If two letters in a row use the same number key, enter the first letter, then press the joystick to the right to move the cursor to the next position to enter the second letter.

For example, to enter Movies:

- 1) Press 6 once to enter M.
- 2) Use joystick, or the right key on the base to move the cursor to the right.
- 3) Press 6 six times to enter o.
- 4) Press 8 six times to enter v.
- 5) Press 4 six times to enter i.
- 6) Press 3 five times to enter e.
- 7) Press 7 eight times to enter s.
- 8) Press the center of the joystick or *menu/select* on the base to end your text entry.

If you make a mistake while entering a name, use the joystick, to move the cursor to the incorrect character. Press the **DELETE** soft key to erase the incorrect character, and then enter the correct character. To delete all characters in the text entry field, press and hold the **DELETE** soft key.

keys	Number of times key is pressed								
	1	2	3	4	5	6	7	8	9
1	1								
2 abc	A	B	C	a	b	c	2		
3 def	D	E	F	d	e	f	3		
4 ghi	G	H	I	g	h	i	4		
5 jkl	J	K	L	j	k	l	5		
6 mno	M	N	O	m	n	o	6		
7 pqrs	P	Q	R	S	P	q	r	s	7
8 tuv	T	U	V	t	u	v	8		
9 wxyz	W	X	Y	Z	w	x	y	z	9
0 oper	&	<	>	<	>	/	(blank)	--	--
	.	,	:	?	!	@	'	"	*
	#	0							

Main Menu Options

On the handset, the options are DirectLink, Room Monitor, Messages, Ringer Options, Speaker Setup, Display Options, Reminder, and System Setup.

Note:

- If you do not press a key within 30 seconds, the phone will time out and exit the menu mode. When setting the Date and Time, the time-out period is extended to two minutes.
- All of these options can be configured in the Cordless Customization Application.

Handset Main Menu Options



DirectLink



Room Monitor



Messages



Ringer Options



Speaker Setup



Display Options



Reminder



System Setup



On the base, the options are Rings/Volumes, Caller ID, Redial, Phonebook, Room Monitor, and System Setup.

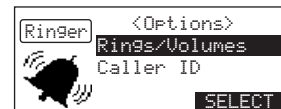



Through this section we use the handset display screens for examples.

Handset / Base



System Setup

LCD
Contrast

Key Touch
Tone

System Setup Menu

System Setup

The following submenu options must be set separately for each handset and the base.

LCD Contrast (For Base)

You can change the contrast of your base display to make it easier to read. You might want to adjust the contrast whenever you change the display color. Your phone gives you 10 levels of contrast to choose from. To adjust the contrast, go to **LCD Contrast**. Use the up or right key to increase the contrast and the down or left key to decrease the contrast. When you like the level of contrast, press **menu/select** or press the **SELECT** soft key to select it.

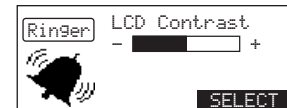

Key Touch Tone

Key Touch Tone is the tone your keypad makes when keys are pressed. To turn off the tone, go to **Key Touch Tone** and select **Off**. A confirmation tone tells you that the tone has been deactivated.

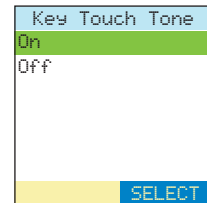

Call Privacy

If you don't want other registered handsets or the base to interrupt you on a call, you can turn on privacy mode. As long as your handset or the base is in privacy mode, other handsets won't be able to join your call or make any calls of their own. To turn on privacy mode, go to **Call Privacy** and select **On**. You can turn on privacy mode when the phone is in standby or when you're already on a call.

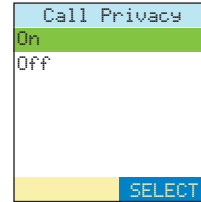

Language (For Base)

You can change the language the menu display will use. Choose from English, French, or Spanish. To change the language, go to **Language** and select **English**, **Français** (French), or **Español** (Spanish). You will hear a confirmation tone, and the display will use the selected language.



Auto Talk (Handset only)

Auto Talk lets you answer the phone by removing the handset from the cradle. To turn on Auto Talk go to **Auto Talk** and select **On**. A confirmation tone tells you that Auto Talk is active.

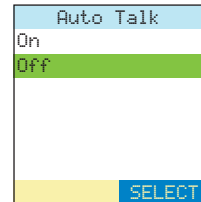

Handset / Base



System Setup

Call Privacy

Language

Auto Talk

Handset / Base



System Setup

LCD
Contrast

Any Key
Answer

Banner
Display

Unique ID

Any Key Answer (Handset only)

Any Key Answer lets you answer the phone by pressing any key on the number pad. To turn on Any Key Answer, go to **Any Key Answer** and select **On**. A confirmation tone tells you that Any Key Answer is active.

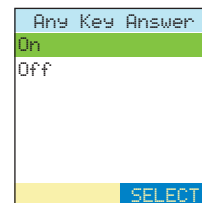

Banner Display (Handset only)

You can change the name your phone displays on the screen. If you have more than one handset, you can use the banner name to identify your handset during handset-to-handset functions like intercom and DirectLink. Go to **Banner Display** and enter the name you want to use. You can use up to 10 characters. Use the **DELETE** soft key to delete an existing handset name. Press the center of the joystick when you're finished.

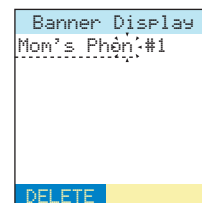

Unique ID (Handset only)

You can assign special ringer tones to anyone in your phonebook. When your phone gets a call, it looks up the Caller ID information in your phonebook; if you assigned a distinctive ringer and pictures to that number, the phone uses it so you know who's calling. To turn on distinctive ringing, go to **Unique ID** and select **On**. A confirmation tone tells you that distinctive ringing is active.

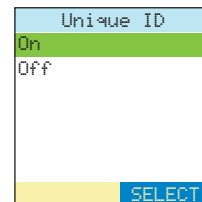

If you don't activate Unique ID, the phone uses the default picture.

Global Setup

Global settings apply to all registered handsets and the base. If you change something under the global menu, you change it for handsets and the base. Only one handset or the base can change global settings at a time, and you have to make sure the phone is not currently being used.



Some features may not be supported by older handsets.

Date and Time

To change the date and time shown in the display, go to Date & Time. Move the cursor up, down, right, or left to highlight the part you want to change (date, time, AM/PM). Use the number keypad, the up or down key, or **/tone* to change each part. Press the center of joystick or *menu/select* on the base when you finish.

Note: If you don't press any keys for two minutes when setting the date and time, the phone will exit the menu mode.

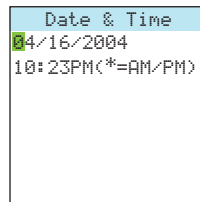

System Setup

Global

Date &
Time



System Setup

Global

Call
Waiting

Area Code

Call Waiting

Your phone supports Caller ID with Call Waiting, so you can see the name and number of someone who calls when you are already on the line. Your phone also supports Call Waiting Deluxe, which gives you a choice of how you want to handle a waiting call. You need to subscribe to these features with your phone company before you can use them.

To let your phone support these features, go to **Call Waiting**. Select **On**, and the phone will display the CallWaitDeluxe screen. Select **On**. (You have to turn on Call Waiting before you can turn on Call Waiting Deluxe.) A confirmation tone tells you that your phone is ready to use these features.

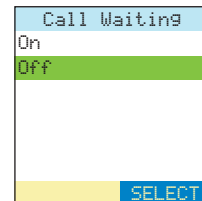

Area Code

If you can make a call by dialing only 7 digits (instead of 10), you can program your local area code in your phone. If you get a call from within your area code, you'll only see the 7-digit phone number. If you get a call from outside your area code, you'll see all 10 digits.

To enter an area code, go to **Area Code**. Use the number keypad to enter your 3-digit area code. Press the center of the joystick or **menu/select** on the base when you finish.

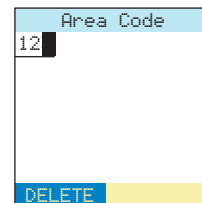

Dial Mode

Your phone can communicate with the telephone network in two different ways: tone dialing and pulse dialing. These days, most phone networks use a method called tone dialing, so your phone comes programmed for tone dialing.

If your phone company uses `PULSE` dialing, you will need to change your phone's dial mode. There's an easy way to tell: try making a call. If your call connects, your phone's setting is fine. If not, go to `Dial Mode` and select `Pulse`. A confirmation tone tells you that the dial mode has been changed, and you can try making a call again.

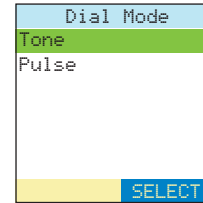

System Setup

Global

Dial Mode



(Base:Rings/Volumes)

Ringer Tones

Setting the Ringer Options

This menu lets you customize ringer or speaker volume settings on your phone. You can set these options separately for the base and each handset.



Ringer Tone

You can set a different ringer for each handset and the base. This phone comes with 10 prerecorded songs and 15 different ringer tones; for the handset you can also record your own ringer tones (see page 31).

- Songs: Beethoven's Symphony #9 [Beethoven9], For Elise [Elise], Home Sweet Home [Hm Swt Hm], Lorri Song #6 [Lorri Song], WT Overture (Handset only), Twinkle Star (Handset only), Je Te Veux (Handset only) When the Irish Eyes Are Smiling [Irish Eyes] (Base only), Aura Lee (Base only), Let Me Call You Sweet Heart [Sweetheart] (Base only), Star Spangled Banner [Star Spngl], Old MacDonald [Old MacDld], We Wish You A Merry Christmas [Merry-Xmas]
 - Ringer tones: Flicker, Clatter, Coin Toss, Synthesize, Finish Line, Soft Alert, Wake Up, Lighting Bug, Bebop, Tone Board, Chirp, Party Clap, Reminder, Burble, TeleTone,
- 1) Go to **Ringer Tones** and highlight the ringer you want. (Each ringer will sound as you highlight it.)
 - 2) Select a ringer from the list.
 - 3) Press the center of the joystick or **menu/select** on the base to confirm the setting. You will hear a confirmation tone, and the phone will go back to the menu.

Unique Ring Setup (Base Only)

You can assign special ringer tones to anyone in your phonebook. When your phone gets a call, it looks up the Caller ID information in your phonebook; if you have assigned a distinctive ringer to that number, the phone uses that ring so you know who's calling.

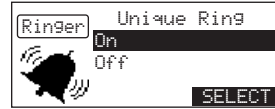

To turn on distinctive ringing, go to **Unique Ring** and select **On**. A confirmation tone tells you that Unique Ring is active.

Customize Your Own Distinctive Ringer Tones (Handset Only)

Your phone can store up to 5 different recordings (a total of 100 seconds) to use as ringer tones. Each recording must be less than 20 seconds long.

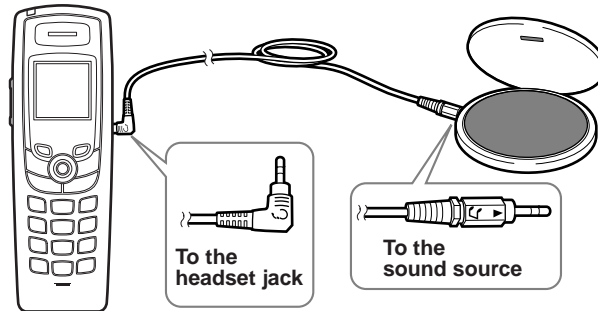

(Ringer Options)
(Base:Rings/Volumes)

Unique Ring

Rec/Edit
Rings

Storing Ringer Tones

- 1) Connect the audio recording cable to the handset and sound source (e.g. stereo or CD player). Insert one end of the audio recording cable into the handset's headset jack and the other end into the sound source. You can also simply use the handset's microphone by holding the handset close to the sound source.
- 2) Go to `Rec/Edit Rings`.
- 3) Select a location from 1-5, and press the **OPTIONS** soft key.
- 4) Select `Record`. To start recording, press the **RECORD** soft key. The message counter displays 20 and then begins to count down.
- 5) When you are finished recording, press the **STOP** soft key. The phone will play the recorded ringer. To re-record the ringer, press the **ReRec** soft key while playing the ringer.
- 6) Enter the title of this ringer (up to 12 digits) using the number keypad, or the **DELETE** soft key, right, or left key.
- 7) Press the center of the joystick. You will hear a confirmation tone, and `Done!` appears.



Playing the Ringer

- 1) Go to `Rec/Edit Rings`.
- 2) Select a ringer to play, and press the **OPTIONS** soft key.
- 3) Use the joystick to select `Play`. To stop, press the center of the joystick or the **STOP** soft key.

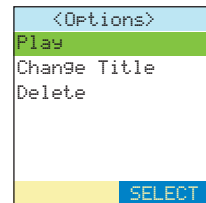

Changing Ringer Name

- 1) Go to **Rec/Edit Rings**.
- 2) Select a ringer you want to change the title, and press the **OPTIONS** soft key.
- 3) Use joystick to select **Change Title**.
- 4) Edit the title of this ringer (up to 12 characters) using the number keypad, the **DELETE** key, and the right/left key.
When you are finished, press the center of the joystick, you will hear a confirmation tone, and **Done!** appears.



Delete Ringer

To delete a ringer tone, go to **Rec/Edit Rings**, and select the ringer you want to delete. Press **OPTIONS** soft key. Use the joystick or the up/down key to select **Delete**. Select **Yes**. You will hear a confirmation tone, and **Deleted!** appears. The ringer is deleted from the list, and the phone stays on the ringer list.

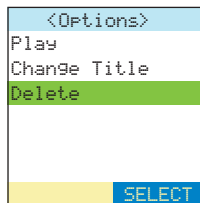

You can not delete the ringer if it is currently set as the default ringer tone, as a Unique Ring in the phonebook, or as a Reminder.



DisplayOptions

Wall Paper

Display Settings (Handset Only)

The following submenu options must be set separately for each handset.

Wall Paper (Handset Only)

Your phone has 34 preset wallpaper/images to choose from. You can customize or replace 30 of these images using the software application CD-ROM supplied with this phone.

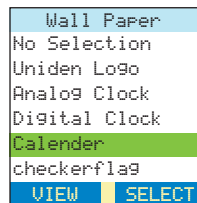

During standby mode, the wallpaper will display on the Handset's LCD Screen. To set your wallpaper, scroll through Wall Paper options, and press the **VIEW** soft key. Press the center of the joystick to activate the wallpaper of your choice.

- You can download images of your own by using the PC software.

Color Scheme (Handset Only)

You can change the color of your phone's display. There are 5 different colors to choose from: Sky Blue, Haze Gray, Chic Purple, Coral Red, and Lime Green.

To change the color of the display, go to `Color Scheme` and select the color you want. As you scroll through the options, the phone displays the highlighted color for you.

LCD Contrast (for the handset)

LCD Contrast adjusts the handset's display. To adjust the contrast, go to `LCD Contrast` and use the joystick to adjust the contrast level you want. A confirmation tone tells you the contrast level has been activated.



DisplayOptions

Color Scheme

LCD Contrast



DisplayOptions

Animation Type

Language

Animation Type (Handset only)

Your phone has 4 different animations (Dog, Car, Frog and Abstract) with 7 different animation schemes:



delete



done



page



talk



batt-low



end



unavailable

To set your animation type, scroll through Animation Type options, and press the **VIEW** soft key. Press the center of the joystick or press the **SELECT** soft key to activate the animation type of your choice.



Language (for the Handset)

You can change the language the menu display will use. Choose from English, French, or Spanish. To change the language, go to Language and select English, Français (French), or Español (Spanish). You will hear a confirmation tone, and the display will use the selected language.



Using Your Phone

Making Calls

From the Handset

- 1) Remove the handset from the charging cradle.
- 2) Press **talk/flash**.
- 3) Listen for the dial tone.
- 4) Dial the number.

OR

- 1) Remove the handset from the charging cradle.
- 2) Dial the number.

If you need the phone to pause before dialing more digits (for example, to enter an access code or extension), press the center of the joystick, and select **Pause Entry** from the list. **P** appears in the display, which represents a 2-second pause.

- 3) Press **talk/flash**.

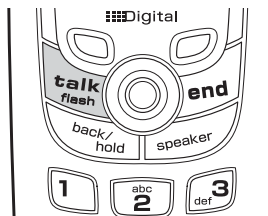

- When you dial the number from the handset in standby mode, hyphens are inserted between numbers.
- If the line is already in use, all registered handsets and the base that are not currently in use will display **InUse**.



For best performance, use the speaker phone in a quiet room and let the caller finish speaking before you speak. If you or the other party has difficulty hearing, adjust the speaker volume.

From the Handset Speakerphone

- 1) Remove the handset from the charging cradle.
- 2) Press **speaker**.
- 3) Listen for the dial tone.
- 4) Dial the number.
- 5) When the other party answers, talk into the microphone located at the bottom of the handset.

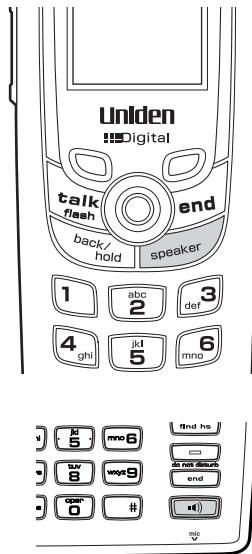

From the base

- 1) Press **speaker**.
- 2) Listen for the dial tone.
- 3) Dial the number.

OR

- 1) Dial the number.
If you need the phone to pause before dialing more digits (for example, to enter an access code or extension), press the center of the joystick, and select **Pause Entry** from the list. **P** appears in the display, which represents a 2-second pause.
- 2) Press **speaker**.

Receiving a call

Handset is in the cradle	Handset is off the cradle
Remove the handset from the charging cradle and press talk/flash . If Auto Talk is ON, the phone will automatically answer the call when you pick up the handset (see page 25).	Press talk/flash . If Any Key Answer is on, you can also press any key on the number pad to answer a call. (see page 26)

From the base

Press **Ⓜ**.

Hanging Up

From the handset press **end** or return the handset to the charging cradle.

From the base, press **end**.

Switching to the Handset Speakerphone During a Call

To switch a normal call to the speakerphone, press **speaker**. To switch from a speakerphone call to a normal call, press **speaker**.



- To scroll through the help, press the >>| soft key.
- You must subscribe through your local telephone company to receive Call Waiting or Caller ID with call waiting service.
- Your phone can't show call waiting caller ID information when a call is on hold.

Moving out of range

If you move your handset farther from the base unit during a call, you might start to hear more noise than usual. If you go too far from the base, you will hear a beep and see `No Signal Press HELP`. Press the **HELP** soft key on the display.

Call Waiting

If you hear a call waiting tone while you are on a call, press **talk/flash** or **flash** on the base to switch to the new call. After a short pause, you will hear the new caller. Press **talk/flash** or **flash** on the base again to go back to the original caller.

Call Waiting Deluxe

If you subscribe to Call Waiting Deluxe (CWDX) from your phone company, you have several different options when you get a call waiting call. When you hear the call waiting tone, instead of answering the call, you can press the center of the joystick or **menu/select** on the base, or the **OPTION** soft key, and then select `CallWaitDeluxe`. Use joystick or the up/down key or press 1-7 to choose from the following options:

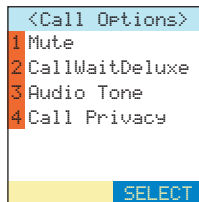

Option	Definition	Press
Ask to Hold	A prerecorded message tells the caller that you will be available shortly, and the call is placed on hold.	1
Tell Busy	A prerecorded message tells the caller you are busy, and the waiting call is disconnected.	2
Forward	The caller is sent to your voice mail box, if available.	3
Answer/Drop 1	Disconnects the first call, and connects to the new caller.	4
Conference	Starts a conference call with your first and second callers.	5
Drop First/Drop Last	During a conference call, allows you to choose to drop the first or last caller.	6 / 7

Placing a Call on Hold

During a call, press **back/hold/intercom** or **hold/intercom/transfer**, to put the call on hold. Press **talk/flash** or **Ⓜ** the base to go back to the call.

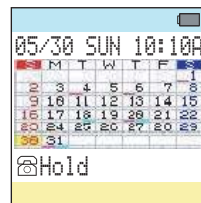



- If you leave a call on hold for a more than 5 minutes, a warning tone sounds and Hold Reminder! Answer held line appears, and the line will disconnect in 15 seconds.
- If someone is using another handset or base in Privacy Mode, Unavailable appears in the display, and you cannot join the call.

Conferencing

If you have more than one handset, up to four people can participate in a conference call.

3-Way Conferencing

- Outside line + Handset + Base (or Handset)

4-Way Conferencing

- Outside line + Handset + Handset + Base

Joining a Conference Call

You can easily join a call already in progress.

From the base

- 1) Press **4** on the base to join the conference call.
- 2) To hang up, press **end**. The handset(s) will still be connected to the call.

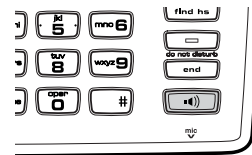

From the handset

- 1) Press **talk/flash** or **speaker** on the handset to join the call.
- 2) To hang up, return the handset to the cradle or press **end** on the handset. The base or other handset will still be connected to the call.

Invite someone to a conference

Press **back/hold/intercom** or **hold/intercom/transfer** on the base. Select the handset or the base to invite into the conference.

Press **talk/flash** or **speaker**, or **Ⓜ** on the base to join the conference.

The initiate handset or base returns to standby mode.

press **talk/flash** or **speaker**, or **Ⓜ** on the base to join the conference.

Redialing Calls

You can quickly redial the last 20 phone numbers dialed from each handset and 10 numbers from the base.

With the phone in standby mode, slide the joystick down (or press **menu/select**, and then select **Redial** on the base). This brings up the redial list. Use the joystick or up/down key to scroll through the numbers, and select the number you want to dial.

Press **talk/flash** (or **speaker**,) or **Ⓜ** on the base to dial the selected number.

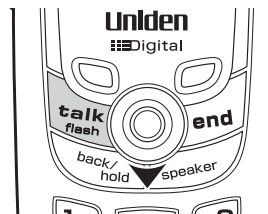
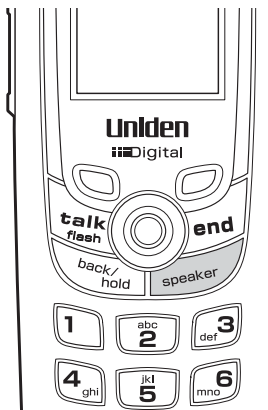

- Each redial record can store up to 32 digits.
- To store redial numbers in the Phonebook, see page 55.

You can also display the redial list with the phone in talk mode. After selecting the number, press the **DIAL** soft key to dial the number.

Deleting Redial Records

If you want to delete a phone number from the redial list, go to the redial list in standby mode, and select the number you want to delete. Press the **OPTIONS** soft key, and select `Delete Selection`, and then select `Yes`. Press the center of the joystick or **menu/select** on the base. The redial record is deleted. If you want to delete all the redial records, select `Delete All`, and then `Yes`. Press the center of the joystick or **menu/select** on the base. All redial records are deleted.

Adjusting Base Ringer and Speaker Volumes

Adjusting the base ringer volume

You can choose from three ringer volume settings on the base: off, low, and high. When the phone is in standby mode, go to `Rings/Volumes` menu, and then select `Ringer Volume`. Use the up/down/left/right key to select the ringer volume, and then press **menu/select**. You will hear a confirmation tone.

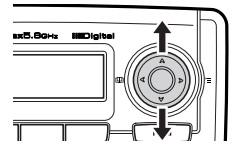

Adjusting the base speaker volume

You can adjust the volume of speaker on the base while the phone is in use. Press the up/down to choose one of the 10 volume levels.

You can also set the speaker volume from the menu. Go to `Rings/Volumes` menu, and then select `Speaker Volume`. Use the up/down/left/right key to select the speaker volume, and then press **menu/select**. You will hear a confirmation tone.

Using the Handset Volume Options

Ringer: Adjust the handset ringer volume

You can choose from three different ringer volume settings on your handset: off, low, and high. When the phone is in standby mode, go to the Ringer Options menu, and then select Ringer Volume. Use the joystick to select the ringer volume, and press the center of the joystick or press the **SELECT** soft key. You will hear a confirmation tone.

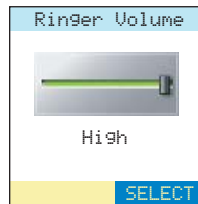

Earpiece speaker:

You can choose from six volume levels for the earpiece speaker. To adjust the volume, go to Speaker Setup menu, and select Earpiece Volume and select the volume level you want to use.

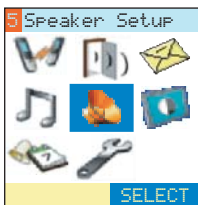

You can also adjust the earpiece volume during a call by pressing the Δ or ∇ keys on the side of the handset to make it louder or softer.



(Speaker Setup)

Speaker Volume

Audio Tone

Speaker: Adjust the handset speaker volume

You can choose from six volume levels for the handset speakerphone. To adjust the speaker volume, go to **Speaker Setup** menu, and select **Speaker Volume**, and then select the volume level you want to use.

You can also adjust the handset speaker volume during a call by pressing the ∇ or \triangle key on the side of the handset to make it louder or softer.



Audio Tone

If you aren't satisfied with the audio quality of your phone, you can adjust the Audio Tone of the earpiece. Your phone gives you three audio tone options: low, natural or high. Go to **Speaker Setup** menu, and select **Audio Tone** and select the option that sounds best to you.

(Audio tone adjustments only apply to the earpiece, not the speakerphone.)

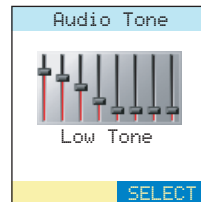

Mute

While the handset is ringing, you can mute the handset ringer for this call by pressing **end** on the handset. To mute the base ringer, press **end** on the base. The phone will ring as normal on the next call.

Mute the Microphone

When you're on the phone, press the center of the joystick or **menu/select** on the base and select **Mute** to turn off the microphone so the caller will not hear you. The display shows **Mute On**, and \otimes or \boxtimes while the microphone is muted. To turn off muting, repeat the above step again. **Mute Off** appears.

Tone Dialing Switch Over

If your telephone company uses pulse dialing, you can switch over to tone dialing after the call connects. This feature is useful when you need tone dialing to use any automated menu systems, such as automated banking, prescription refill lines, customer support menus, etc.

If your phone is set to pulse dialing mode, make your call normally. Once your call connects, press ***/tone** on the handset or base. Any digits you enter from then on will be sent as tone digits. When this particular call ends, the phone automatically returns to pulse dialing mode.

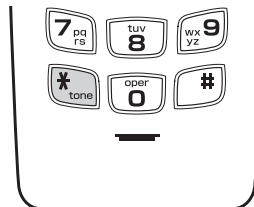

Privacy Mode

Privacy mode prevents interruption from other registered handsets or the base. This works only when the phone is in use. While on a call, press the **OPTIONS** soft key on the handset or the base. Use the joystick or the up/down key to select Call Privacy. Privacy Mode On and  appear in the display. To exit Privacy Mode, use the same procedure. Privacy Mode Off appears.

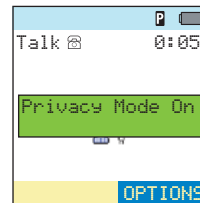

Do Not Disturb (DND)

The **do not disturb** feature (DND) allows you to mute the ringer of the base and any registered handsets at the same time. The phone must be in standby mode. Press and hold **dnd** on the base. You will hear a confirmation tone, and the dnd LED illuminates. To cancel the DND feature, press **dnd** again. You can also mute the ringer tone while the phone is ringing by pressing **dnd** on the base.



You must subscribe to voice mail service from your telephone company in order to use this feature. The telephone company will provide you with the access number.



System Setup

Handset (Base)

Edit Voice Mail

Find Handset

To locate the handset, press **find hs** on the base when the phone is in standby mode. Select the handset to page. The handset beeps for 60 seconds, and **Paging** appears on the handset display. To cancel paging, press any key on the handset or **end** on the base.

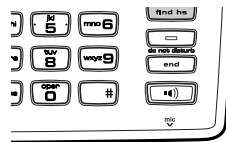

Using One Touch Voice Mail Access

If you subscribe to voice mail service, you can use your phone to access your voice mailbox. The new message LED flashes or  appear, whenever you have messages waiting in your voice mailbox. Just program the phone with your access number, and you can access your messages at the touch of a button on the handset. (The service provider will supply you with the access number. This number may be simply a phone number. Refer to the provider's literature).

When you have messages, press the joystick up. If you have not entered the access number or it has been deleted, when you press the joystick up. **No access no. Store number in Edit Voice Mail** appears and you will hear a beep. The phone returns to standby mode.

Programming your Voice Mail Access Number

Your phone can program or delete the voice mail access number. To edit the voice mail number, go to Edit Voice Mail and then enter your personal access number (up to 20 digits). Press the center of the joystick or **menu/select** on the base when you are finished.

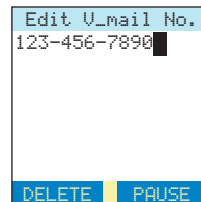

If you have an access number already entered, the current number will appear in the display. To delete that number, press the **DELETE** soft key. If you need to have the phone wait before sending the next digits, press the **PAUSE** soft key. Press the center of the joystick or *menu/select* on the base when you finish.

A P appears in the display each time you press the **PAUSE** soft key; each pause inserts a two-second delay in the dialing sequence, and each pause counts as one digit.

Voice Mail Tone

Your telephone service provider should provide you with the specifics of your voice mail service upon your enrollment. If you are having trouble with your message waiting indicator on your phone not illuminating when you have waiting messages, you will need to contact your service provider and inquire as to which type of message signal (SDT or FSK) their service is using.

If your voice mail service uses a SDT message signal to alert you of a new voice mail message, you will need to turn on the Voice Mail Tone.

If your voice mail service uses a FSK message signal to alert you of new voice mail messages, you can turn the Voice Mail Tone off. To turn off Voice Mail Tone, go to Voice Mail Tone and select Off.

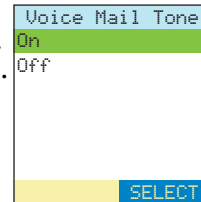

Resetting the New Message LED for Base

If the LED remains on after you've retrieved your messages, you may need to reset the indicators. To reset the New Message LED, go to VMWI Reset and press the **SELECT** soft key or *menu/select*, you will hear a confirmation tone.



System Setup

Global

Voice Mail
Tone

VMWI
Reset

Reminder (Handset only)



Date & Time must be set to use the Calendar features. To set the Date & Time, scroll to Global System Setup options (see page 27).

Your phone has a built-in calendar that you can use to schedule reminders and appointments (all the way through December 31, 2099). You can set alarms for up to 30 different events.

A pop-up screen appears and a reminder tone sounds when the scheduled time & date arrives. To show detailed info on the reminder, press the **VIEW** soft key. To mute the reminder tone, press the **MUTE** key.

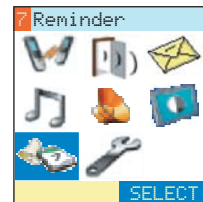

To reset the reminder and clear the screen, press **end** when the reminder tone stops. To dismiss Reminder display press DISMISS appears. Press the **DISMISS** soft key. The phone returns to standby mode.

Scheduling a reminder

Select the reminder option to show Reminder (Calendar). Today is highlighted. If the reminder is set for the morning, a bar appears in the lower left of the date number; if the reminder is set for the afternoon or evening, a bar appears in the lower right of the date number. Use up, down, right or left key to move the cursor to the desired date.

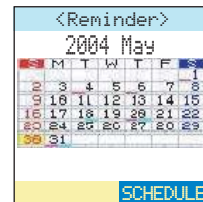

- 1) Press the center of the joystick to select a date.
- 2) Press the **STORE** soft key to add a reminder.
- 3) Press the center of the Joystick to set the date and time.
- 4) Use the number keypad or ***/tone** to select the hours and minutes. Press the center of the joystick when you finish.
- 5) To change the title, select **!** and press the center of the joystick. Use the number keypad, left, right key, and the **DELETE** soft key. Press the center of the joystick when you finish.
- 6) If you want to set recurrence, press **Q**, and press the center of the joystick. Select the frequency (None, Daily, Weekly, Monthly, Yearly) from the list. Press the center of the joystick when you finish.
- 7) If you want your phone to ring when this reminder occurs, move to the line **♪** indicated, and press the center of the joystick. Select the ringer tone you want the phone to use. Press the center of the joystick when you finish.
- 8) To enter a reminder text for this reminder, select **⌨** and press the center of the joystick. *Edit Message* appears. You can enter up to 80 characters. Press the center of the joystick when you finish.
- 9) When everything is correct, press the **DONE** soft key.

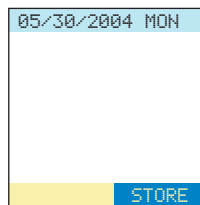

Editing and deleting reminders

You can edit reminders by pressing the **SCHEDULE** soft key and selecting the reminder by pressing the **OPTIONS** key. Once the reminder is selected, you can edit the date, time, reminder tone, and text the same way you entered them for a new entry. To delete reminder, select the reminder and press the **OPTIONS** soft key. Select *Delete Selection*. To delete all reminders, select *Delete All*.

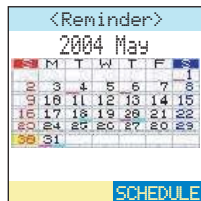

Using the Phonebook

Your phone lets you store up to 100 entries in each handset and base. You can store up to 4 phone numbers for each name in your phonebook (for a total of 400 numbers), and you can assign names to groups for easy searching. You can store a distinctive ringer tone and picture display, to each name and group.

You can enter your phonebook by sliding the joystick to the left (or by pressing the phonebook key on the base).

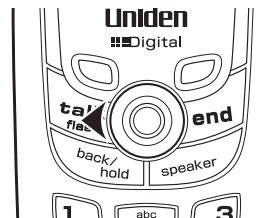

Creating and Editing Phonebook Entries







Enter the phonebook menu and press the **STORE** soft key for the first entry. From the 2nd entry, enter the phonebook menu and then the **OPTIONS** soft key. Select *New Entry* to store, or *Edit Selection* to edit the location. Enter as much of the information as you want. Press the center of the joystick or *menu/select* to enter each entry and confirm the selection. When you finish, press the **DONE** soft key to save this phonebook entry.

Step 1: Name /N

Select /N and use the keypad to enter the name for this entry. You can enter up to 16 characters. If you don't want to enter a name, your phone will store this entry as No Name. Press the center of the joystick or **menu/select** when you finish, and your phone will go back to the current phonebook entry.

Step 2: Number /☎

Select /☎ and enter a phone number for this entry. If you need your phone to pause between digits when it's dialing (for example, to enter an extension or an access code), press the **PAUSE** soft key to insert a two-second pause. You'll see a P in the display. You can stack more than one pause together if two seconds is not long enough. Each pause counts as one digit; you can enter up to 20 digits for the phone number. Press the center of the joystick or **menu/select** when you finish, and your phone will go back to the current phonebook entry.

You can select an icon to remind you which number this is: home , , work , , mobile , , or general phone number. Press the center of the joystick or **menu/select** when you finish.

Step 3: Unique Ring /🎵

Select /🎵 to attach a special ring to this entry. Select the ringer tone you want the phone to use when this person calls, or select No Selection to have the phone use its regular ringer tone. Press the center of the joystick or **menu/select** on the base when you finish, and your phone will go back to the current phonebook entry.

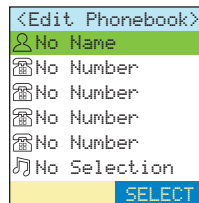



You can save up to 4 numbers for each phonebook entry. You must delete one of the existing numbers before you add a new one.

Step 4: Unique Display (Handset only)

Select  to attach a special screen display to this entry. Select the display you want the phone to use when this person calls, or select *No Selection* to have the phone use its regular display. You can press the **VIEW** soft key to see the display choices.

Press the center of the joystick when you finish, and your phone will go back to the current phonebook entry.

Step 5: Group /

Select  /  to place this entry into a phonebook group. Select the group (0-9) you want this entry to belong to, or select *No Selection* to leave the entry outside of any group. Press the center of the joystick or **menu/select** when you finish, and your phone will go back to the current phonebook entry. See page 58 for information on creating and editing groups.

Step 6: Speed Dial /

Select **0-9** to save this number to one of the 10 speed dial numbers or *No Selection* if you don't want to save it to a speed dial number. If a phone number already exists for the speed dial number you select, your phone will ask if you want to overwrite the number. Press the center of the joystick or **menu/select** when you finish, and your phone will go back to the current phonebook entry.

Storing Caller ID or Redial Numbers in the Phonebook

You can store Caller ID or redial numbers in your phonebook so you can use them later. Go to the Caller ID list or redial list and select the number you want to store. (If the Caller ID information did not include the number, then you will not be able to store it.)

- 1) With the phone in standby mode, go to the Caller ID list or redial list and select the number you want to store.
- 2) Press **OPTIONS** soft key, and then select *Add to Phonebook*.
- 3) Use the joystick or the up/down key to select *New Entry* to enter a new phonebook location. If you want to add a number to the existing phonebook location, select *Store & Edit*, and then select a location to edit.
- 4) Enter each entry and confirm the selection by following the steps in pages 53-54.

Storing and Editing Numbers from the Dial Operation

- 1) With the phone in standby mode, enter the number to store using the number keypad.
- 2) Press the center of the joystick or *menu/select* and select *Add to Phonebook*.
- 3) Use the joystick or the up/down key to select *New Entry* to enter a new phonebook location. If you want to add a number to the existing phonebook location, select *Store & Edit*, and then select a location to edit.
- 4) Enter each entry and confirm the selection by following the steps in pages 53-54.



You can save up to 4 numbers for each phonebook entry. If you try to save more than 4 numbers for a phonebook entry, your phone will display *Dial data is full*. You will have to delete one of the existing numbers before you can add a new one.

Managing the Phonebook

With the **OPTIONS** soft key, you can delete phonebook entries, copy entries to another handset or base, check how many empty phonebooks and speed dial entries you have available, sort your phonebook by groups, and name phonebook groups.

Deleting phonebook entries

Go to the phonebook and select the entry you want to delete. Press the **OPTIONS** soft key and select `Delete Selection`. Your phone will ask you to confirm, select `Yes`.

To delete all the entries from your phonebook, go to the phonebook and press the **OPTIONS** soft key without selecting an entry. Select `Delete All`. Your phone will ask you to confirm, select `Yes`.

Copying phonebook entries to another handset

Note: When you copy entries to another handset or base, the group and speed dial information won't be transferred. Your phone will cancel the copying process if any one of the following occurs:

- If the handset you are copying to does not have enough memory (the phone will show "Not enough memory in receiving unit").
- A call comes in during the copying process.

To copy a single entry, go to the Phonebook and select the entry you want to copy. Press the **OPTIONS** soft key and then select **COPY Selection**. Select the handset or base you want to copy the entry to. Your phone will ask you to confirm, select **Yes**.

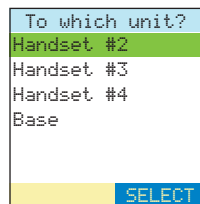

To copy all the phonebook entries, go to the phonebook and press the **OPTIONS** soft key without selecting an entry. Select **COPY All**. Select the handset or base you want to copy the entry to.

Checking the number of stored entries

To see how many phonebook entries you have, go to the phonebook and press the **OPTIONS** soft key and select **PhoneBk Capacity**. The phone will show you how many stored names (entries) and how many stored phone numbers (total) you have.

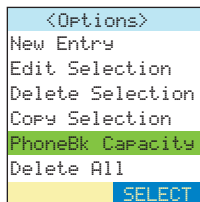

To see your speed dial entries, go to the phonebook and press the **OPTIONS** key and select **Check * Dial**. The phone will show you which speed dial entries have phone numbers stored in them.

Changing the sorting order

To change the sorting order of your phonebook entries, go to the phonebook and press the **OPTIONS** soft key and select **Sort**. Then select **Alphabetically** by pressing the center of the joystick or **menu/select** on the base to see the list of names in alphabetical order; select **GROUP** by pressing the center of the joystick or **menu/select** on the base to see the list of groups in alphabetical order. For alphabetical order, enter a letter from the keypad to jump to the first entry beginning with that letter.

Naming phonebook groups

Your phone comes with 10 groups to help you organize phonebook. You can name groups things like "Family" or "Friends" or "Softball team" to let you find entries in your phonebook more quickly.

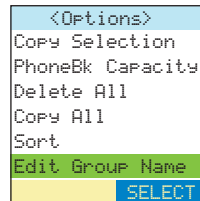

Follow the steps below to name a group:

- 1) Go to the Phonebook and select the **OPTIONS** soft key.
- 2) Scroll down to `Edit Group Name` and press the center of the joystick or **menu/select** on the base.
- 3) Scroll down to the group number you want to edit, and press the center of the joystick or **menu/select** on the base.
- 4) Use the number keypad to enter a name for this group. Press the center of the joystick or **menu/select** on the base when finished.

Making Calls with the Phonebook

To call someone in your phonebook, go to the phonebook and select that person's phonebook entry and press the center of the joystick or **menu/select** on the base. Select the number (one of the four available) that you want to call, and then press **talk/flash** or **speaker** or **Ⓜ** on the base. You can also dial the number with the phone in talk mode. After select number, press the **DIAL** soft key. The phone will dial the number at the top of the list.

Using the Speed Dial

With the phone in standby mode, press and hold the number of the speed dial entry you want to call until the phonebook entry appears. Select the number (one of the four available) that you want to call, and then press **talk/flash** or **speaker** on the handset or **Ⓜ** on the base.

Caller ID Features

If you subscribe to Caller ID from your phone company, your phone will show you the caller's phone number and name (if available) whenever a call comes in.

If you subscribe to both Call Waiting and Caller ID the phone also shows you the name and the number of any incoming calls when you are already on the phone with a caller.

Using the Caller ID List

You can store up to 100 Caller ID numbers in each handset or the base. To see the Caller ID list, slide the joystick to the right (or by pressing the Caller ID key on the base). The phone will show the Caller ID list. You can use the joystick or the up/down key to scroll through the list, or you can enter a letter with the keypad to jump to the first caller ID name that starts with that letter.

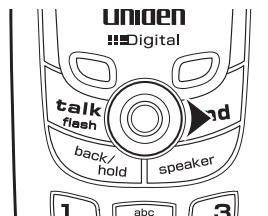
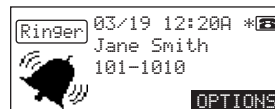
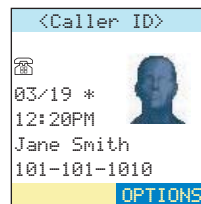



When you delete a Caller ID number, you delete it permanently from the caller id list

If you want to see how many Caller ID numbers are stored in your phone, slide the Joystick to the right or press the Caller ID key on the base, and then the **OPTIONS** soft key. Select **CID Capacity**.

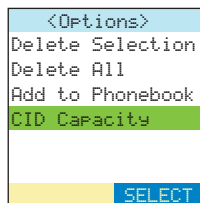

Calling someone from the Caller ID list

Go to the Caller ID list and select the number you want to call. If you need to add a "1" to the number for a long distance call, press ***/tone**. If you need to add your saved area code to the number, press **#**. Then press **talk/flash** or **speaker** on the handset, or **(M)** on the base.

Deleting Caller ID numbers

To delete only one Caller ID number, go to the Caller ID list and select the number you want to delete. Press the **OPTIONS** soft key, and select **Delete Selection**. When the phone asks you to confirm, select **Yes**.

To delete all the Caller ID numbers, go to the Caller ID list and press the **OPTIONS** soft key. Select **Delete All**. When the phone asks you to confirm, select **Yes**.

Multi-Handset Features

The features in this section require a minimum of two handsets to operate. To add additional handsets to your system, see "Expanding Your Phone" on page 12.

Using DirectLink Mode

In DirectLink Mode, a pair of handsets can function as two-way radios. DirectLink Mode does not interfere with the base's ability to make or receive telephone calls. You must set both handsets to DirectLink Mode to make a directlink call.

To enter DirectLink mode, select the Direct Link option from the main menu, and then press the **ENTER** soft key.

Direct Link Mode complete appears once the selection is confirmed.

To make a DirectLink call, press the **DirectLink** soft key. Select the handset you want to call. To answer a DirectLink call, press talk/flash or if Any Key Answer is on, press any number key, ***/tone** or **#** key. Press **end** when you want to hang up.

To exit DirectLink mode and be able to receive normal phone calls again, press the **CANCEL** soft key, and then press the **OK** soft key.

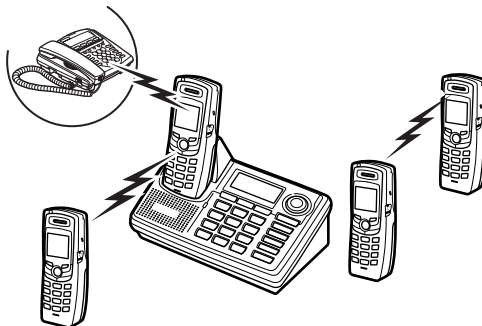

- If the party is out of range, No Signal appears in the display, and the operation will be canceled.
- While a pair of handsets are in Intercom DirectLink Monitor mode, they cannot be used to make or receive calls. Other handsets can still make and receive calls.





- This feature only works when the handset is within the range of the base.
- If the party is out of range, *Unavailable* appears in the display, and the operation will be canceled.

Room/Baby Monitor

This feature allows you to monitor sounds in another room. Place a handset or the base in the room you wish to monitor; it will function as a microphone. A second handset or the base can be used as a remote speaker, allowing you to monitor sounds in the room.

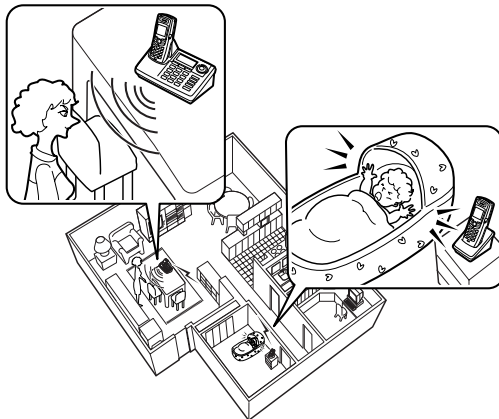

Using Room/Baby Monitor

To enter Room Monitor mode, press the center of the joystick or **menu/select**. Select the Room Monitor option and then select the handset or base you want to monitor. Press **end** when you want to stop monitoring.

To prevent the monitoring of a particular handset or the base, simply turn off the Room Monitor feature on that handset or on the base.

To turn off the Room Monitor, go to System Setup, select Base from the base menu or select Handset from the handset menu; then **Room Monitor** and select **off**. You will hear a confirmation tone.



Intercom

You can use the intercom to talk to another handset or base without using the phone line. While the phone is in standby mode, press **back/hold/intercom** or **hold/intercom/transfer**. Select the handset or base you want to page. If you select All, all other handsets and the base will be paged.

If the handset or base you are trying to page is busy, the phone displays `System busy Please try later`. If the handset you are trying to page is out of range, the phone displays `No Signal`. Press `HELP` and the page is canceled.

Intercom	
All	
Handset	#2
Handset	#3
Handset	#4
Base	
	SELECT

Answering an intercom page

When the handset receives an intercom page, it sounds a tone and shows the ID of the handset that is paging. To answer the page, pick up the handset and press **talk/flash, speaker, or back/hold/intercom** on the handset, ***41** or **hold/intercom/transfer** on the base.

- If you receive an outside/intercom call or page while selecting the other handset, the operation is canceled.
- If the party does not answer within one minute, the operation is canceled.
- During an intercom call, if you receive a call, you will hear a ringer tone from the ear speaker.
- If all handsets are paged, only the first party to answer the page will connect.
- If you do not select a handset within 30 seconds, the operation will be canceled.

To hang up an intercom page, press **end** any handset or base.

Transferring a Call

You can transfer calls between the handsets and the base or between any two handsets. During a call, press **back/hold/intercom** or **hold/intercom/transfer** on the handset; this will put the call on hold. Select the handset or base you want to transfer the call to. To cancel the transfer and go back to the caller, press **talk/flash** or **speaker** or **Ⓜ** on the base.

Answering a transfer page

When the handset or base receives a transfer page, it sounds a tone and shows the ID of the handset. Press **talk/flash**, **speaker** or **back/hold/intercom** or **hold/intercom/transfer** to answer the page. If you want to accept the transfer and talk to the outside caller, press **talk/flash**, **back/hold/intercom** or **speaker**, or **Ⓜ** or **hold/intercom/transfer** on the base.

Note on Power Sources

Power Failure

During the period that the power is off, you will not be able to make or receive calls with the telephone.

Optional Power Backup Feature

The phone has an optional backup battery in the base. It provides power backup in the event of a power failure or outage. You will be able to make or receive calls with the telephone.

Battery replacement and handling

When the operating time becomes short, even after the battery is recharged, please replace the battery. With normal usage, your battery should last about one year.

Warning

To avoid the risk of personal injury or property damage from fire or electrical shock, use only Uniden AD-0006 AC adapters and Uniden BT-0003 battery packs with your phone.

Caution

- Use only the specified Uniden battery pack (BT-0003).
- Do not remove the batteries from the handset to charge them.
- Never throw the battery into a fire, disassemble them, or heat them.
- Do not remove or damage the battery casing.



- A replacement Uniden adapter or battery may be purchased by calling Uniden's Parts Department (see back cover page).
- Use only the Uniden (BT-0003) rechargeable battery pack supplied with your cordless phone.

General Information

The phone complies with FCC Parts 15 and 68. Operating temperature:
0 °C to +50 °C (+32 °F to +122 °F)

AC Adapter Information

AC Adapter part number: AD-0006
Input Voltage: 120V AC 60Hz
Output Voltage: 9V DC 500mA

Battery Information

Battery part number: BT-0003
Capacity: 900mAh, 3.6V

Specifications, features, and availability of optional accessories are all subject to change without prior notice.

Troubleshooting

If your phone is not performing to your expectations, please try these simple steps first. If these steps do not solve your problem, please call our Customer Service Hotline at 1-800-297-1023. (Mon - Fri 7 am to 7 pm, Sat/Sun 9 am to 5 pm, CST. The Customer Service Hotline is closed on holidays.)

Symptom	Suggestion
The charge LED won't illuminate when the handset is placed in the cradle.	<ul style="list-style-type: none">• Make sure the AC adapter is plugged into the base or the chargers (if you have more than one handset) and the wall outlet.• Make sure the handset is properly seated in the cradle.• Make sure the charging contacts on the handset are clean.
The charge LED flashes.	<ul style="list-style-type: none">• Clean the charging contacts on the handset.
The audio sounds weak.	<ul style="list-style-type: none">• Move the handset and/or base away from metal objects or appliances and try again.• Make sure that you are not too far away from the base.
Unable to make or receive calls.	<ul style="list-style-type: none">• Make sure that you are not too far away from the base.• Make sure the line is not in use. If an outside call is already in use on a line, you cannot use that line to make another outside call.• Check both ends of the base telephone line cord.• Make sure the AC adapter is plugged into the base and wall outlet.• Disconnect the AC adapter and the backup battery.• Change the Digital Security Code (see page 15).
The handset does not ring or receive a page.	<ul style="list-style-type: none">• Make sure that you are not too far away from the base.• Charge the battery pack in the handset for 15 hours by placing the handset on the base or charging cradle.• Change the Digital Security Code (see page 15).

Symptom	Suggestion
Severe noise interference.	<ul style="list-style-type: none"> • Keep the handset away from microwave ovens, computers, remote control toys, wireless microphones, alarm systems, intercoms, room monitors, fluorescent lights, and electrical appliances. • Move to another location or turn off the source of interference.
The Caller ID does not display.	<ul style="list-style-type: none"> • The call was placed through a switchboard. • Call your local telephone company to verify your Caller ID service is working properly or if there has been a temporary service interruption.
You cannot register the handset at the base.	<ul style="list-style-type: none"> • Charge the battery pack in the handset for 15 hours. • Change the Digital Security Code (see page 15).
The handset does not communicate with other handsets.	<ul style="list-style-type: none"> • Change the Digital Security Code (see page 15). • Make sure that you have registered all handsets.
An extra handset is not able to join the conversation.	<ul style="list-style-type: none"> • Make sure there are not 2 handsets already using the conference feature. • Make sure that another handset is not in privacy mode.
Room Monitor feature does not work.	<ul style="list-style-type: none"> • Make sure to place the handset(s) within the range of the base.

System Reset

De-register the Handset

- 1) Press and hold **end** and **#** for more than 5 seconds. Select Deregister HS.
- 2) The phone will ask you to confirm the deregistration. Select Yes.

When the base information is deleted, the handset displays

MUST Place the handset in base to register! Models may vary, refer to Owners Manual for help. Re-register the handset to the base (see page 14).

Replacing the Base Setting

- 1) Press and hold **end** and **#** for more than 5 seconds. Select Replacing Base.
- 2) Select Yes.
- 3) You will hear a confirmation tone. The base information will be deleted.

When the base information is deleted, the handset displays

MUST Place the handset in base to register! Models may vary, refer to Owners Manual for help. Re-register the handset to the base (see page 14).

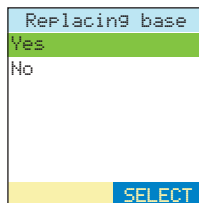
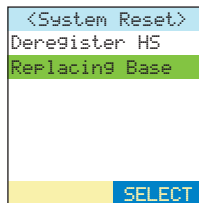
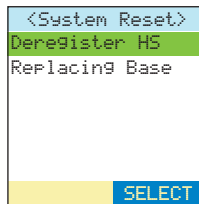

Liquid Damage

Moisture and liquid may damage your cordless phone. Follow the steps below if your phone gets wet:

Case	Action
If the exterior plastic housing on the handset or base is exposed to moisture or liquid.	Wipe off the liquid, and use as normal.
If moisture or liquid has entered the plastic housing (i.e. liquid can be heard in the phone or liquid has entered the handset battery compartment or vent openings on the base).	<p>Handset:</p> <ol style="list-style-type: none">1) Remove the battery cover and leave it off for ventilation.2) Disconnect the battery pack. Leave the battery cover off and the battery pack disconnected for at least 3 days.3) Once the handset is completely dry, reconnect the battery pack and the battery cover.4) Recharge the handset's battery pack for 20 hours before using. <p>Base:</p> <ol style="list-style-type: none">1) Disconnect the AC adapter from the base, cutting off electrical power.2) Disconnect the telephone cord from the base.3) Let dry for at least 3 days. <p>IMPORTANT: You must unplug the telephone line while recharging the battery packs to avoid charge interruption.</p> <p>CAUTION: DO NOT use a microwave oven to speed up the drying process. This will cause permanent damage to the handset, base and the microwave oven. After following these steps, if your cordless telephone does not work, please call our Customer Service Hotline at 1-800-297-1023.</p>

Precautions!

Before you read anything else, please observe the following:

Warning!

Uniden America Corporation DOES NOT represent this unit to be waterproof. To reduce the risk of fire, electrical shock, or damage to the unit, DO NOT expose this unit to rain or moisture.

Rechargeable Nickel-Metal-Hydride Battery

Warning

- This equipment contains rechargeable Nickel-Metal-Hydride batteries.
- The rechargeable batteries contained in this equipment may explode if disposed of in a fire.
- Nickel is a chemical known to state of California to cause cancer.
- Do not short-circuit the battery.
- Do not charge the rechargeable batteries used in this equipment in any charger other than the one designed to charge these batteries as specified in the owner's manual. Using another charger may damage the battery or cause the battery to explode.

Rechargeable Batteries Must Be Recycled or Disposed of Properly



The exclamation point within an equilateral triangle is intended to alert the user to the presence of important operating and maintenance (servicing) instructions in the literature accompanying the appliance.

Uniden works to reduce lead content in our PVC coated cords in our products and accessories.

Warning!

The cords on this product and/or accessories contain lead, a chemical known to the State of California to cause birth defects or other reproductive harm. **Wash hands after handling.**

Important Safety Instructions

When using your telephone equipment, basic safety precautions should always be followed to reduce the risk of fire, electric shock and injury to persons, including the following:

1. Do not use this product near water, for example, near a bath tub, wash bowl, kitchen sink or laundry tub, in a wet basement or near a swimming pool.
2. Avoid using a telephone (other than a cordless type) during an electrical storm. There may be a remote risk of electric shock from lightning.

3. Do not use the telephone to report a gas leak in the vicinity of the leak.
4. Use only the power cord and batteries indicated in this manual. Do not dispose of batteries in a fire. They may explode. Check with local codes for possible battery disposal instructions.
5. Do not disassemble any component of this product.

SAVE THESE INSTRUCTIONS

CAUTION

Risk of explosion if battery is replaced by an incorrect type. Dispose of used batteries according to the instructions. Do not open or mutilate the battery, and disconnect the battery before shipping this product.

The FCC Wants You To Know

This equipment complies with Part 68 of the FCC rules and the requirements adopted by the ACTA. On the bottom of this equipment is a label that contains, among other information, a product identifier in the format US:AAAEQ#TXXXX. If requested, this number must be provided to the telephone company.

An applicable Universal Service Order Codes (USOC) certification for the jacks used in this equipment is provided (i.e., RJ11C) in the packaging with each piece of approved terminal equipment.

A plug and jack used to connect this equipment to the premises wiring and telephone network must comply with the applicable FCC Part 68 rules and requirements adopted by the ACTA. A compliant telephone cord and modular plug is provided with this product. It is designed to be connected to a compatible modular jack that is also compliant. See installation instructions for details.

The REN is used to determine the number of devices that may be connected to a telephone line. Excessive RENs on a telephone line may result in the devices not ringing in response to an incoming call. In most but not all areas, the sum of RENs should not exceed five (5.0). To be certain of the number of devices that may be connected to a line, as determined by the total RENs, contact the local telephone company. For products approved after July 23, 2001, the REN for this product is part of the product identifier that has the format US:AAAEQ#TXXXX. The digits represented by ## are the REN without a decimal point (e.g., 03 is a REN of 0.3). For earlier products, the REN is separately shown on the label.

If this equipment causes harm to the telephone network, the telephone company will notify you in advance that temporary discontinuance of service may be required. But if advance notice isn't practical, the telephone company will notify the customer as soon as possible. Also, you will be advised of your right to file a complaint with the FCC if you believe it is necessary.

The telephone company may make changes in its facilities, equipment, operations or procedures that could affect the operation of the equipment. If this happens the telephone company will provide advance notice in order for you to make necessary modifications to maintain uninterrupted service.

Please follow instructions for repairing, if any (e.g. battery replacement section); otherwise do not substitute or repair any parts of the device except as specified in this manual. Connection to party line service is subject to state tariffs. Contact the state public utility commission, public service commission or corporation commission for information. This equipment is hearing aid compatible.

Should you experience trouble with this equipment, please contact Uniden customer service at 800-297-1023. If the equipment is causing harm to the telephone network, the telephone company may request that you disconnect the equipment until the problem is resolved.

NOTICE: According to telephone company reports, AC electrical surges, typically resulting from lightning strikes, are very destructive to telephone equipment connected to AC power sources. To minimize damage from these types of surges, a surge arrester is recommended.

Changes or modifications to this product not expressly approved by Uniden, or operation of this product in any way other than as detailed in the owner's manual, could void your authority to operate this product.

This device complies with part 15 of the FCC rules. Operation is subject to the following two conditions: (1) This device may not cause harmful interference, and (2) This device must accept any interference received, including interference that may cause undesired operation. Privacy of communications, may not be ensured when using this phone. To insure the safety of users, the FCC has established criteria for the amount of radio frequency energy various products may produce depending on their intended usage. This product has been tested and found to comply with the FCC's exposure criteria. For body worn operation, the FCC RF exposure guidelines were also met when used with the Uniden accessories supplied or designed for this product. Use of other accessories may not ensure compliance with FCC RF exposure guidelines and should be avoided.

Radio Interference

Radio interference may occasionally cause buzzing and humming in your cordless handset, or clicking noises in the base. This interference is caused by external sources such as TV, refrigerator, vacuum cleaner, fluorescent lighting, or electrical storm. Your unit is NOT DEFECTIVE. If these noises continue and are too distracting, please check around your home to see what appliances may be causing the problem. In addition, we recommend that the base not be plugged into a circuit that also powers a major appliance because of the potential for interference. Be certain that the antenna on the unit is fully extended when needed.

In the unlikely event that you consistently hear other voices or distracting transmissions on your phone, you may be receiving radio signals from another cordless telephone or other source of interference. If you cannot eliminate this type of interference, you need to change to a different channel.

Finally, it should be noted that some cordless telephones operate at frequencies that may cause interference to nearby TVs and VCRs. To minimize or prevent such interference, the base of the cordless telephone should not be placed near or on top of a TV or VCR. If interference is experienced, moving the cordless telephone farther away from the TV or VCR will often reduce or eliminate the interference.

Cordless Telephone Privacy

Cordless telephones are radio devices. Communications between the handset and base of your cordless telephone are accomplished by means of radio waves which are broadcast over the open airways. Because of the inherent physical properties of radio waves, your communications can be received by radio receiving devices other than your own cordless telephone unit. Consequently, any communications using your cordless telephone may not be private.

One Year Limited Warranty

Important: Evidence of original purchase is required for warranty service.

WARRANTOR: UNIDEN AMERICA CORPORATION ("Uniden") ELEMENTS OF WARRANTY: Uniden warrants, for one year, to the original retail owner, this Uniden Product to be free from defects in materials and craftsmanship with only the limitations or exclusions set out below.

WARRANTY DURATION: This warranty to the original user shall terminate and be of no further effect 12 months after the date of original retail sale. The warranty is invalid if the Product is (A) damaged or not maintained as reasonable or necessary, (B) modified, altered, or used as part of any conversion kits, subassemblies, or any configurations not sold by Uniden, (C) improperly installed, (D) serviced or repaired by someone other than an authorized Uniden service center for a defect or malfunction covered by this warranty, (E) used in any conjunction with equipment or parts or as part of any system not manufactured by Uniden, or (F) installed or programmed by anyone other than as detailed by the owner's manual for this product. **STATEMENT OF REMEDY:** In the event that the product does not conform to this warranty at any time while this warranty is in effect, warrantor will either, at its option, repair or replace the defective unit and return it to you without charge for parts, service, or any other cost (except shipping and handling) incurred by warrantor or its representatives in connection with the performance of this warranty. Warrantor, at its option, may replace the unit with a new or refurbished unit. **THE LIMITED WARRANTY SET FORTH ABOVE IS THE SOLE AND ENTIRE WARRANTY PERTAINING TO THE PRODUCT AND IS IN LIEU OF AND EXCLUDES ALL OTHER WARRANTIES OF ANY NATURE WHATSOEVER, WHETHER EXPRESS, IMPLIED OR ARISING BY OPERATION OF LAW, INCLUDING, BUT NOT LIMITED TO ANY IMPLIED WARRANTIES OF MERCHANTABILITY OR FITNESS FOR A PARTICULAR PURPOSE. THIS WARRANTY DOES NOT COVER OR PROVIDE FOR THE REIMBURSEMENT OR PAYMENT OF INCIDENTAL OR CONSEQUENTIAL DAMAGES.** Some states do not allow this exclusion or limitation of incidental or consequential damages so the above limitation or exclusion may not apply to you.

LEGAL REMEDIES: This warranty gives you specific legal rights, and you may also have other rights which vary from state to state. This warranty is void outside the United States of America and Canada. **PROCEDURE FOR OBTAINING PERFORMANCE OF WARRANTY:** If, after following the instructions in the owner's manual you are certain that the Product is defective, pack the Product carefully (preferably in its original packaging). Disconnect the battery from the Product and separately secure the battery in its own separate packaging within the shipping carton. The Product should include all parts and accessories originally packaged with the Product. Include evidence of original purchase and a note describing the defect that has caused you to return it. The Product should be shipped freight prepaid, by traceable means, to warrantor at:

Uniden America Service
4700 Amon Carter Blvd.
Fort Worth, TX 76155

I.C. Notice

TERMINAL EQUIPMENT

NOTICE: This equipment meets the applicable Industry Canada Terminal Equipment Technical Specifications. This is confirmed by the registration number. The abbreviation, IC, before the registration number signifies that registration was performed based on a Declaration of Conformity indicating that Industry Canada technical specifications were met. It does not imply that Industry Canada approved the equipment.

NOTICE: The Ringer Equivalence Number (REN) for this terminal equipment is marked on the equipment itself. The REN assigned to each terminal equipment provides an indication of the maximum number of terminals allowed to be connected to a telephone interface. The termination on an interface may consist of any combination of devices subject only to the requirement that the sum of the Ringer Equivalence Numbers of all the devices does not exceed five.

RADIO EQUIPMENT

The term "IC:" before the radio certification number only signifies that Industry Canada technical specifications were met.

Operation is subject to the following two conditions: (1) this device may not cause interference, and (2) this device must accept any interference, including interference that may cause undesired operation of the device. "Privacy of communications may not be ensured when using this telephone".

Index

A

Animations	36
Anykey Answer	26
Area Code	28
Audio Tone	46
Auto Talk	25

B

Banner	26
Battery	
Backup battery	66
Installation	8
Replacement	65
Beltclip	15

C

Calendar	50
Call privacy	25
Call transfer feature	64
Caller ID	
Call Waiting	40
CIDCW	59
CWDX	40
Color Scheme	35
Conference	42

D

Date & time	27
Delete ringer	33
De-registering the handset	69
Dial mode	29
Digital security code	15
DirectLink	61

E

Earpiece volume	45
Expanding your phone	12

F

Find handset	48
--------------	----

G

General information	66
Global setup	27

H

Hands-free conversation	38
Hanging up	39
Headset installation	16
Hold	41

I

I.C. notice	73
Important safety instructions	71
Intercom	63

J

joystick	21
----------	----

K

Key touch tone	24
----------------	----

L

Language	25, 36
LCD contrast	24
Liquid damage	70
Low battery	9

M

Making a call	37
Mute	
Handset ringer	45
Microphone	46

O

Out of range	40
--------------	----

P

Phonebook	
Capacity	57
Copying entries	56
Group	54
Making calls	58
Name	53
Number	53
Sort order	57
Speed dial	54
Unique display	54
Unique ring	53
Power failure	65
Precautions	71
Privacy mode	47

R

Receiving a call	39
Record ringer	31
Redialing a call	43
Register the handset	13
Reminder	50
Ringer Tone	
Changing title	33
Deleting	33
Playing	32
Storing	32
Ringer volume	
Base	44
Handset	45
Room/baby monitor	62

S

Setting up	
Base unit	10
Telephone Line	10
Soft Key.	20
Speaker phone	38
Speaker volume	
Base	44
Handset	46
Storing a caller ID or redial number	55
System Setup	24

T

Tone dial	47
Transferring a call	64
Troubleshooting	67

U

Uniden's Cordless Telephone	
Customization Tool.	16
Unique ID	26
Unique Ring	31

V

Voice Mail	
Access	48
Program	48
Tone	49

W

Wallpaper.	34
Warranty	72

Memo

Memo

At Uniden, we'll take care of you!

Thank you for purchasing a Uniden product. If you have any questions or problems,
please do not return this product to the place of purchase.



Having Trouble?

Our customer care specialists are here to help you! Visit our website at www.uniden.com or call our Customer Service Hotline at **1-800-297-1023**, Mon-Fri, 7 a.m. to 7 p.m. or Sat/Sun, 9 a.m. to 5 p.m. CST. (The Customer Service Hotline is closed on holidays.)



Need a Part?

To order headsets, additional handsets, replacement batteries or other accessories, visit our website at www.uniden.com or call 1-800-554-3988, Mon-Fri, 8 a.m. to 5 p.m. CST.



Help for our Special Needs Customers

If you need special assistance due to a disability or have questions on the accessibility features of this product, please call **1-800-874-9314 (voice or TTY)**

Uniden®

May be covered under one or more of the following U.S. patents:

4,797,916	5,381,460	5,426,690	5,434,905	5,491,745	5,493,605
5,533,010	5,574,727	5,581,598	5,650,790	5,660,269	5,661,780
5,663,981	5,671,248	5,696,471	5,717,312	5,732,355	5,754,407
5,758,289	5,768,345	5,787,356	5,794,152	5,801,466	5,825,161
5,864,619	5,893,034	5,912,968	5,915,227	5,929,598	5,930,720
5,960,358	5,987,330	6,044,281	6,070,082	6,125,277	6,253,088
6,314,278	6,418,209	6,618,015	6,671,315	6,714,630	6,782,098
6,788,920	6,788,953				

Other patents pending.

FOR
ACCESSORIES,
GO ONLINE @
WWW.UNIDEN.COM

REGISTER ONLINE TODAY!

THANK YOU FOR BUYING A UNIDEN PRODUCT.

A World Without Wires | **Uniden[®]**